

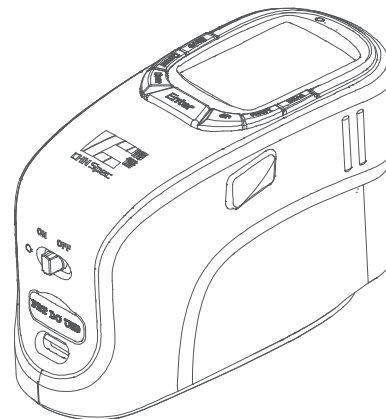

领先的中国色彩与光泽分析专家  
China's leading expert of color and gloss analysis



## 分光系列测色仪 产品使用说明 ▶ CS-600C/600CG



**杭州彩谱科技有限公司**  
HANGZHOU CHNSPEC TECHNOLOGY CO.,LTD

地址：杭州市经济技术开发区文渊北路166号7楼

全国免费电话：4007-7272-81

传真：0571-85888727

---

# CATALOGUE

## 目录

---

[一] 分光测色仪使用须知	01
[二] 分光测色仪注意事项	01
[三] 分光测色仪功能描述	02
[四] 分光测色仪技术参数	02
[五] 外观结构介绍	03
[六] 测量流程图	05
[七] 程序界面介绍	06
[八] 测量	06
8.1 标样测量	07
8.2 试样测量	07
[九] 数据查看	08
[十] 设置	10
10.1 测量设置	10
10.2 系统设置	14
10.3 颜色校准	17
10.4 光泽校准	18
[十一] USB通信	18
[十二] 配件介绍	20
[十三] 系统配置图	21
[十四] 异常处理	22
[十五] 测试结果分析	22
[十六] 公司声明	22

## 分光测色仪使用须知

- 1、分光测色仪是国内分光技术平台的测色仪，本机采用创新的45°/0环形照明系统，剔除了方向依赖性，无论改变样品位置、倾斜样品或旋转仪器均可达到较高的精度和重复性，将纹路带来的影响降到最低。主要用于测量样品的光谱数据、光谱图、色度值、色差值、呈现合格/不合格、色彩仿真示意图等。结构紧凑轻便测试稳定性好、操作简易。
- 2、分光测色仪广泛应用于实验室、工厂、或现场操作，足以在几乎所有应用领域的质量控制中实现优秀的色彩测量。
- 3、限制性保修的时间段是自购买本仪器开始起（时间：如一年）的时间。如果您的仪器需要服务，请将仪器带到当地的销售部或通过网址：www.hzcaipu.com 联系我们来进行维修。
- 4、为了避免仪器精度受影响，请不要将仪器私自拆开。如果由于私自拆卸机器或不正确的使用而导致仪器损坏，请用户自行负责。

## 注意事项

- 1、本机属精密仪器，不能承受因跌落而导致的碰撞，使用时请放置于相对平整的地方。
- 2、本机不能防潮或抗潮，受潮或液体溅入易损坏本机，需在干燥的地方存放。
- 3、本机的屏幕是由玻璃制成，受到异常外力或锐器的作用易损坏。
- 4、本公司建议使用原配电源适配器。
- 5、为保障本机正常工作，请不要在过冷或过热的地方存贮和使用，也勿将本机放置在潮湿或阳光长期直射的地方，更不要在强震等恶劣的环境中使用本机，以免发生意外。
- 6、为了保证测试的准确性，请在测试之前仔细检查锂电池。
- 7、本机是精密仪器，使用时请避开强电磁干扰。
- 8、为保证测量准确，请不要用本机测量不平整的表面。
- 9、为保证测量准确，测试时请保持仪器平稳，不要摇晃。
- 10、测试时请将仪器的测试口紧贴测试物体表面，但不要用力按压。
- 11、本机属精密仪器，使用完毕请将仪器装入包装箱内保管。
- 12、本机及说明书如有进一步改进或补充，恕不另行通知。如有疑问，敬请垂询本公司。

## 分光测色仪功能描述

- 1、可实现多个颜色参数的测试：  
E\*ab, E\*ch, E\*uv, E\*cmc(2:1), E\*cmc(1:1), E&94, E\*00,  
Eab(Hunter),555色调分类,CIE-L\*a\*b\*,L\*C\*h,L\*u\*v,XYZ,Yxy,  
反射率,Hunter-lab,Munsell MI,CMYK等具体详看技术参数；
- 2、大容量存储空间；
- 3、超大TFT显示屏；
- 4、良好的人机交互界面；
- 5、采用LED光源，使用寿命更长；
- 6、低功耗设计，大容量可充电锂电池配置；
- 7、具有低电能提示功能，数据空间满提示功能；
- 8、USB传输数据，PC软件管控色彩数据；
- 9、可连接微型打印机进行打印。

## 技术参数

型号	CS-600C	CS-600CG
功能	颜色	颜色、60°光泽
测量条件	45/0 (45° 环形照明、垂直接收)	
测试口径	11mm	
波长范围	400-700nm	
波长间隔	10nm	
传感器	高灵敏度硅光电二极管	
照明光源	LED	
重复性	分光反射率：标准偏差在0.08%以内。色度值：E*ab 0.03（校正后，以间隔5s测量白板30次标准偏差），最大值0.05	
台间差	E*ab 0.2以内（在12块BCRA II板上测量的平均值）	
语言	中文、英语	
标准观察者	2°/10°	
观察光源	A,C,D50,D55,D65,D75,F1~F12,CWF,U30,DLF,NBF,TL83,TL84,U35	
色空间	CIE-L*a*b,L*C*h,L*u*v,XYZ,Yxy,反射率,Hunter-lab,Munsell MI,CMYK	
色差公式	E*ab, E*CH, E*uv, E*cmc(2:1), E*cmc(1:1), E*94, E*00, Eab(Hunter),555色调分类	
指数	WI(ASTM E313-00,ASTM E313-73,CIE/ISO,AATCC,Hunter,Taube Berger Stensby),YI(ASTM D19 25,ASTM E313-00,ASTM E313-73),Tint(ASTM E313,CIE,Ganz),同色异谱指数Milm,沾色牢度,变色牢度,ISO亮度,A密度,T密度,M密度,E密度	
测量角度	60°	
测量区域	5x10 mm	

测量范围		0 - 1000 GU
重复性		0.2 GU(0 - 100GU) 0.2%(100 - 1000GU)
重现性		1.0 GU(0 - 100GU) 1.0%(100 - 1000GU)
光源寿命	10年300万次	
语言	中文、英文	
显示屏	2.8寸全色真彩屏	
储存	20000条	
接口	USB	
电源	可重复充电, 连续测量20000次, 7.4V/6000mAh	
工作环境	0 - 45 , 相对湿度 80% 或更低 (在 35 ° C下), 无水气凝结	
尺寸	350*300*200mm (L*W*H)	
重量	约800g (不含电池)	
标准配件	电源适配器、锂电池、说明书、颜色管理软件、驱动软件、说明书电子版、颜色管理教程、数据线、黑白校正盒、便携包	
	光泽校准盒	

- ① 测试指示灯
- ② 显示屏
- ③ 保存键
- ④ 取消/后退键
- ⑤ 通过按Up、Down键, 来改变数值、移动小数点的位置和选择功能
- ⑥ 确认键
- ⑦ 菜单键
- ⑧ 打印功能快捷键,定位
- ⑨ 测试孔
- ⑩ 测试面板
- ⑪ 电池盖

## 外观结构介绍

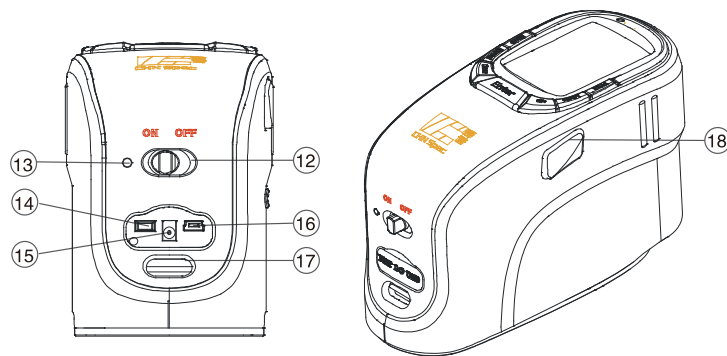
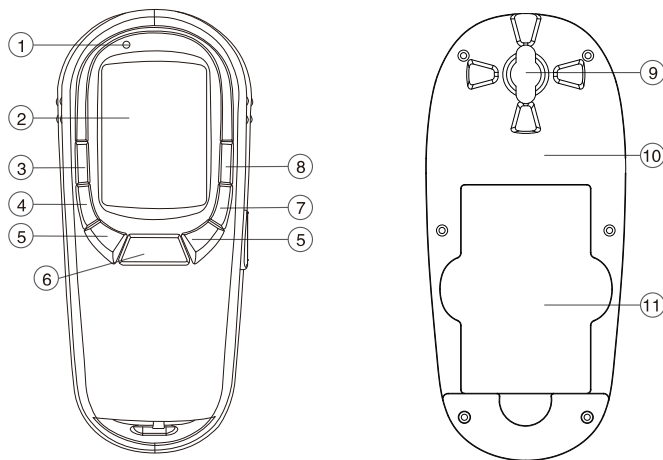

- ⑫ 开、关机键
- ⑬ 电源指示灯
- ⑭ 微型打印机接口
- ⑮ 直流适配器插孔
- ⑯ USB端口
- ⑰ 绳钩
- ⑱ 测试键

## 测量流程图

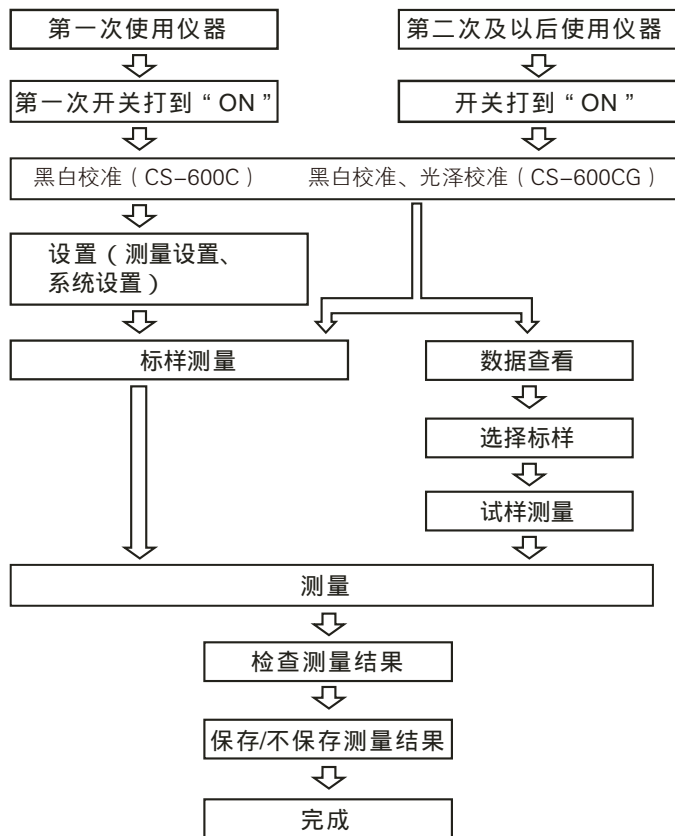

## 程序界面介绍

A-1

主页面

标题栏：显示当前页面的主要功能信息。

工作区：显示页面下属于菜单的主要功能或是测试时的数值。

状态栏：指引当前操作情况。



程序基本操作方法

通过Up、Down选择键，选择“相应的功能按钮”，按“Enter”键进入“选择的功能界面”进行相应操作，按“Cancel”键返回上一步骤，“Save”键对测试结果或状态设置进行保存，“Menu”调出菜单，“Print”输出打印测试数据。

测量：用户可以测量样品的各项颜色参数，测量样品与标样之间的颜色差异测试以及查看所保存的测试记录等。

数据查看：在该页面中用户可以查看已保存的标样下的各项参数。并可对选择的样品进行查看试样、删除和编辑名称操作。

设置：用户可以对仪器测量条件的各项参数进行选择设置。

USB通信：用户可以通过USB接口与PC机连接进行数据传输，以及进行上位机操作。

## 测量

在主页面，通过Up、Down选择键，选择“测量”图标，“Enter”键进入“测量”页面。

在该页面下，用户可以测量样品的色空间、色度指标参数，查看样品的光谱反色率等信息。还可以测量样品与标样之间的色差、色度指标参数，查看样品与标样的光谱反射率对比，以及查看对样品合格与否的判断。

## 标样测量



注：G60参数只在CS-600CG型号中有

B-1

测试结果的标题栏中，第一列为标样名称，当按“Save”键保存后，显示为保存之后的标样名，若标样未保存，则标样名称一律显示为“Txxx”。

第二列为测试结果的测量条件，格式为光源/观察者，测量前可在“测量设置”中进行设置（参看设置）。第三列为可查看的内容，可通过“Enter”键选择查看测量标样的光谱反射率数据。

查看标样测量中光谱反射率时，通过Up、Down键移动光标，即可查看不同波长反射率值。

## 试样测量



注：G60参数只在CS-600CG型号中有

C-1

在上面的标样测量完成并保存后，按“Menu”键，即可进入该标样下的“试样测量”界面，按“Test”键进行测量，“滴”声后完成色差测量，查看测量结果。再次按下“Test”键可进行新的色差测量。与标样测量相同，试样测量在未保存时，在测量结果的标题栏中，第一列名称中的试样名称显示为“Sxxx”，保存后则显示为保存后的名称。

在“数据查看”界面下，同样可以进行色差测量。通过Up、Down键选择已有的标样，按“Enter”键进入查看所选的标样。然后在“查看标样”页面下，按“Menu”键，进入该标样下的试样测量界面，按“Test”键进行测量。“滴”声后完成色差测量，查看测试结果。再次按下“Test”键进行新的色差测量。

注：色差测量前请先设置容差。（参看容差设置）

在“试样测量”页面中，可按“Enter”键，通过Up、Down选择光谱反射率。

## 数据查看

D-1

在主页面，通过Up、Down选择键，选择“数据查看”图标，按“Enter”键进入“数据查看”页面，查看已保存标样名称、试样数、测试时间以及色彩仿真等信息。



### D-2

通过Up、Down选择键选择所需查看的标样，按“Enter”键即可查看所选标样的测试数据。



[Enter]-查看标样 [Menu]-菜单

D-2

通过Up、Down选择键选择所需查看的标样，按“Menu”键，即可弹出菜单窗，通过Up、Down选择键，进行查看试样、删除、编辑名称等操作。

### D-3

查看试样：查看所选样品作为标样下的所有色差测试记录。按“Menu”键即可在弹出如图所示的菜单窗，对所选测试记录进行删除、编辑名称等操作。

删除：将删除该条试样下的所有测试记录。

编辑名称：编辑更改所选样品的名称。

全部删除：将删除全部试样测试结果。



[Enter]-查看标样 [Menu]-菜单

D-3

## 设置

通过Up、Down选择键选择“设置”图标，按“Enter”键进入“设置”页面，有测量设置、系统设置、颜色校准和光泽校准。



E-1/1

### E-1/1

测量设置：在该页面下，用户可以对仪器测量中的显示、光源、观察者、容差、平均、保存、加标样进行设置。

系统设置：在该页面下，用户可以对语言、时间、电源管理进行设置，以及对仪器进行恢复出厂设置，查看本仪器的版本号信息。

颜色校准：在该页面下，用户可以对仪器进行黑白校准。

光泽校准：在该页面下，用户可以对仪器进行光泽校准。

## 测量设置

E-2/1 通过Up、Down选择键选择，按“Enter”键进入“测量设置”页面。



E-2/1

E-3/1

显示设置：通过Up、Down选择键选择“显示”，按“Enter”键进入显示设置页面。按Up和Down键，选择您所需要显示的色空间、色坐标或者指数，按Enter键确认。当您选择某一项后，测量页面将显示您所选的内容。

注：“同色异谱”按Enter键后，可以对需要进行同色异谱比较的光源和观察者角度进行设置。

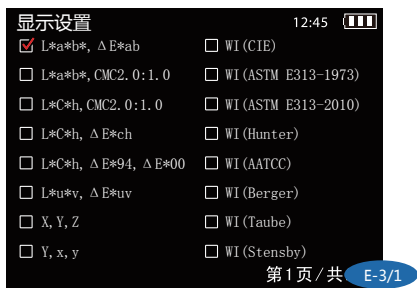

E-5/1

观察者：通过Up、Down键选择“观察者”，按“Enter”键进入观察者选择页面。本仪器提供2°、10°两种标准观察视角，通过Up、Down键选择。



E-4/1

光源选择：通过Up、Down选择键选择“光源”，按“Enter”键进入光源设置页面。本页下面可以选择在测量页面显示任一种光源下的测量数据。本仪器提供A光源、C光源、D50光源、D55、D65光源、D75光源、F1光源、F2光源、F3光源、F4光源、F5光源、F6光源、F7光源、F8光源、F9光源、F10光源、F11光源、F12光源、CWF光源、U30光源、DLF光源、NBF光源、TL83光源、TL84光源，U35,共25种光源。通过Up和Down键进行选择光源选择。

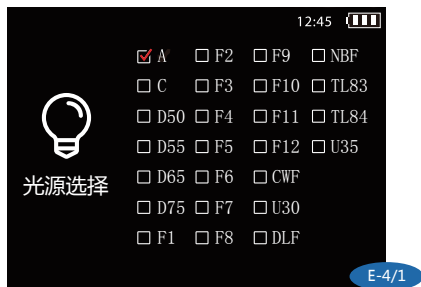

E-6/1

容差设置：通过Up、Down键选择“容差设置”，按“Enter”键进入容差设置页面。Up、Down键修改数值，按“Enter”键确认。



E-7/1

平均设置：通过Up、Down键选择“平均设置”，按“Enter”键进入平均设置页面。Up、Down键修改平均测试次数，按“Enter”键确认。



E-9/1

添加标样：通过Up、Down键选择“加标样”，按“Enter”键进入添加标样选择页面。通过Up、Down键和Enter键可选择多种颜色空间，具体设置所需要的颜色标量，然后进行添加，颜色模拟区域可对设置的标样提供直观的视觉参考。



E-8/1

保存设置：通过Up、Down键选择“保存设置”，按“Enter”键进入保存设置页面。Up、Down键选择手动保存或自动保存，按“Enter”键确认，其中勾选自动保存后每次标样测量与试样测量均会自动保存（例如显示为T040和S001），而勾选手动保存则不会自动保存（即显示为Txxx和Sxxx）。



## 系统设置

F-1/1

通过Up、Down选择键选择，按“Enter”键进入该“系统设置”页面。“系统设置”页面中可进行：语言设置、时间设置、电源管理、恢复出厂、查看版本等操作。



F-2/1

语言选择：通过Up、Down选择键选择“语言选择”，按“Enter”键进入语言设置页面。本仪器提供英文、中文两种界面语言，通过Up、Down键选择。



F-3/1

时间设置：通过Up、Down选择键选择“时间设置”，按“Enter”键进入时间设置页面。设置修改本仪器的测量显示时间，可对年、月、日、时、分进行设置，Up、Down键选择修改项，“Enter”键确认，再按Up、Down键修改数值，按“Cancel”键选择保存、退出。

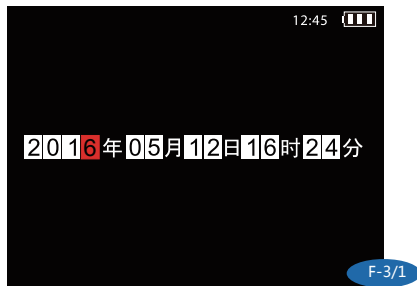

F-4/1

电源管理：通过Up、Down选择键选择“电源管理”，按“Enter”键进入电源管理页面。可对仪器的背光时间、关机时间进行修改设置。Up、Down键选择修改项，“Enter”键确认，再按Up、Down键修改数值，按“Cancel”键选择保存、退出。

(注：背光时间设置为0时代表不关背光；关机时间设置为0时代表不自动关机)



F-5/1

恢复出厂：通过Up、Down选择键选择“恢复出厂”，按“Enter”键进入恢复出厂页面。恢复出厂后，所有的数据将会被删除，并且设置系统将会恢复到默认设置。选择保存、退出。



F-6/1

版本：通过Up、Down选择键选择“版本”，按“Enter”键进入版本查看页面。显示本仪器的版本号信息，包括仪器型号、产品序列号、软件版本号以及公司名称。

(注：版本号若有更改，恕不另行通知。)

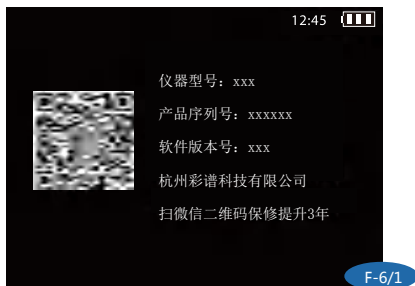

## 光泽校准



H-1

将仪器测试口放在光泽校准盒上，按“Enter”键进行校准。短鸣“滴”声后完成光泽校准。

## 颜色校准



G-1

将仪器测试口放在黑腔上，按“Enter”键进行校准。短鸣“滴”声后完成黑校准；黑校准完成后，将仪器测试口放在白板上，按“Enter”键进行校准，短鸣“滴”声后完成白校准。

## USB通信



在主页面上，通过Up、Down选择键，选择“USB通信”图标，按“Enter”键，进入“USB通信”页面。

使用本仪器标配的USB数据线将仪器与PC机相连，根据提示安装驱动（驱动程序在本仪器提供的光盘内，具体软件的使用请参考软件的帮助文档）当驱动程序正确安装，将如图显示。正确安装后即可在PC机上进行上位机操作。

当USB线未插入USB接口或USB线与USB接口接触不良时，将如图显示。插入USB接口或重新插入即可正常连接，进行上位机操作。



## 配件介绍



主机(含锂电池组件)

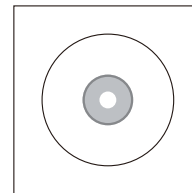

数据管理软件光盘

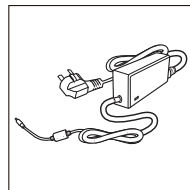

外部电源适配器

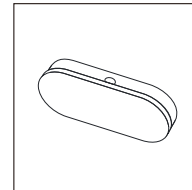

黑白校准盒

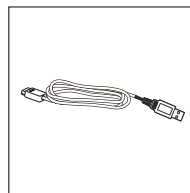

USB数据线

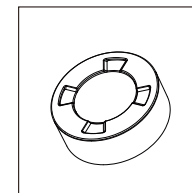

光泽校准盒  
(属CS-600CG标配件)

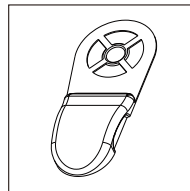

定位板(可选附件)

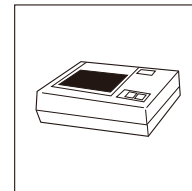

打印机(可选附件)

## 系统配置图

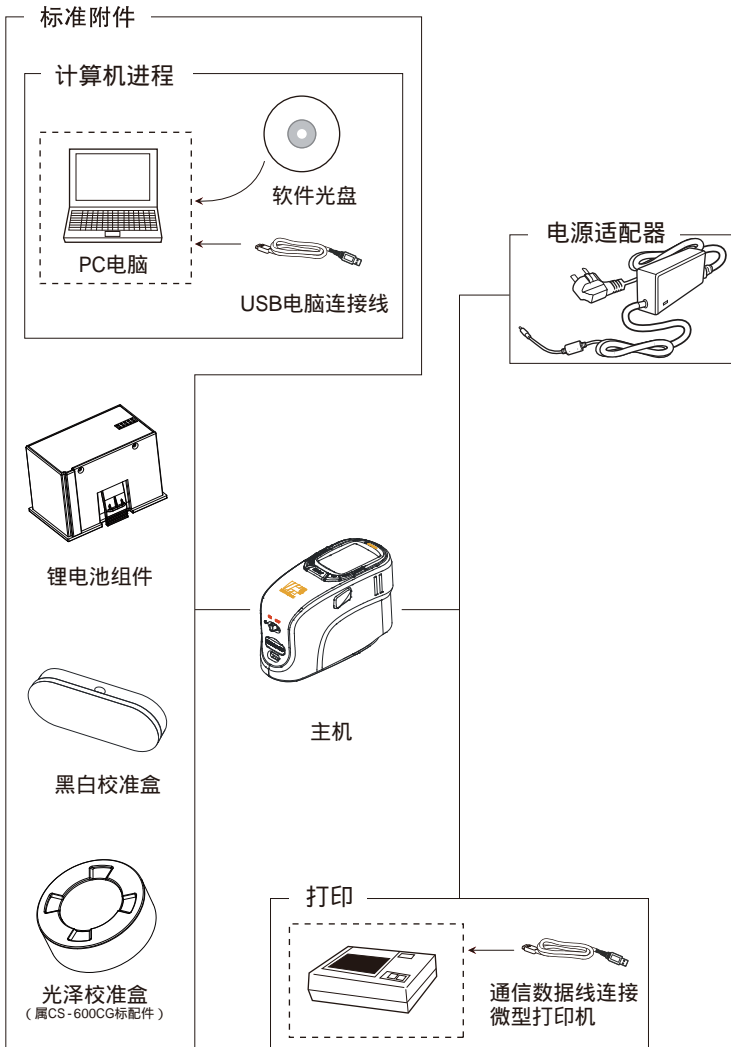

## 异常处理

异常情况	分析	处理方法
1、仪器无法开机	1、检查仪器是否连接到外部直流电源适配器或是否装了电池组 2、检查电池电量是否充足	安装电池或插入直流电源
2、开机后不能进入主程序	1、检查是否进行过校准 2、检查校准过程是否有误	重新进行校准再次进入
3、测量结果报错	检查容差设置是否合理	重新调整容差设置
4、测试数值异常	1、检查测量时仪器及测试品是否平稳，测量口与测量面接触是否紧密良好 2、检查测量物体是否太薄漏光 3、检查测量部位是否是混色	1、保持仪器及测试品平稳 2、在测试品底部放置一个厚的塑料垫或一张白纸 3、测量单一颜色部分，不要测量混色部位使用直流电源
5、两次测量结果相差较大	检查电池消耗是否在20%以下	使用直流电源

## 测试结果分析：

▼ E总色差的大小  $E^*ab = \sqrt{(L^*)^2 + (a^*)^2 + (b^*)^2}$

L+值表示偏白，L-值表示偏黑；a+值表示偏红，a-值表示偏绿；b+值表示偏黄，b-值表示偏蓝。当一种颜色用CIEL\*a\*b\*表示时，L\*表示明度值；a\*表示红/绿值及b\*表示黄/蓝值。

▼ CIE LAB

CIE LAB色空间是基于一种颜色不能同时既是绿又是红、也不能同时既是蓝又是黄这个理论而建立。所以，单一数值可用于描述红/绿色及黄/蓝色特征。当一种颜色用CIE\*a\*b\*表示时，L\*表示明度值；a\*表示红/绿值及b\*表示黄/蓝值。

▼ CIE LCH

CIE LCH颜色模型采用了同L\*a\*b\*一样的颜色空间，但它采用L\*表示明度值；C\*表示饱和度值及h表示色调角度值的柱形坐标。

## 公司声明

本公司向用户承诺，我们生产的测色仪系列产品，保修期限为购买之日起的三年内有效，正常使用情况下非人为造成的故障问题，本公司将负责给予免费维修，超过保修期或人为因素导致的故障，本公司将提供维护，将收取维修材料及相关费用。（详细保修参看彩谱保修细则）

本公司对于第三者因使用本产品引起的任何损失或索赔不负任何责任。本公司对由于因故障、维修或断电造成的数据丢失而导致的任何损害或损失均不负任何责任。为防止重要数据的丢失，请务必对所有重要数据进行备份。本产品中预置的所有作品之版权归属彩谱公司所有，受《中华人民共和国著作权法》保护。

我公司出售本产品的行为不代表向用户转让或授予与作品版权相关的任何权利。本说明书所提到的产品规格及信息仅供参考，内容亦会随时更新，恕不另行通知最新版本可到 [www.hzcaipu.com](http://www.hzcaipu.com) 查询。



China's leading expert of color  
and gloss analysis



## SERIES OF SPECTROPHOTOMETER

OPERATION MANUAL ▶

CS-600C/600CG

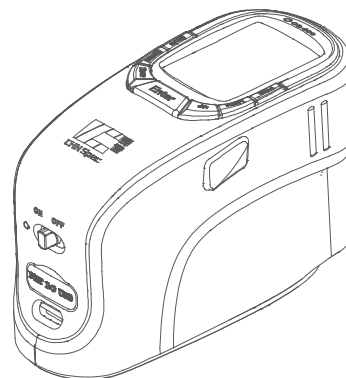

Service hotline:+86 571 85888707

Address:No.166,Wenyuan North Road,Jiangan District,Hangzhou City,China



Please do not disassemble the product without the assistance of  
customer support center, If you have any questions, please contact the  
local agency.

[www.chnspec.com](http://www.chnspec.com)

---

# CATALOGUE

---

[ I ] Term of Use	01
[ II ] Notes	01
[ III ] Instrument functions	02
[ IV ] Technical Parameters	02
[ V ] Appearance and structure	03
[ VI ] Measurement flow chart	05
[ VII ] Program interface	06
[ VIII ] Measurement	06
8.1 Target measurement	07
8.2 Sample measurement	07
[ IX ] Data view	08
[ X ] Settings	10
10.1 Measurement setup	10
10.2 System setup	14
10.3 Color calibration	17
10.4 Gloss calibration	18
[ XI ] USB communication	18
[ XII ] Accessories	20
12.1 Standard accessories	20
12.2 System deployment graph	21
[ XIII ] Trouble Shooting	22
[ XIV ] Testing Result Analysis	22
[ XV ] Company's statements	23

## Terms of use

1. Our spectrophotometer is the first model in China that incorporates spectrum splitting technology in the measurement of color. This instrument adopts 45/0 geometry, directional dependence is eliminated, regardless of changing the sample position, tilting sample or rotating instrument can achieve higher accuracy and repeatability. It is mainly used to measure the sample's spectral data, spectral graph, color values, color differences and so on. The structure is compact and handy; measurement is easy to carry out, accurate and precise.
2. Our spectrophotometer is widely used in factories, labs and on spot. It can achieve great color measurement result in the quality control of almost all fields.
3. The warranty period starts from the date you purchase the spectrophotometer. If you need warranty service, please contact local agency or visit our website [www.chnspec.com](http://www.chnspec.com) to contact us.
4. To avoid damage to instrument accuracy or precision, please do not disassemble the instrument. Damage to the instrument caused by

## Notes

1. Carefully put the instrument on a flat surface.
2. This instrument is not moisture proof, please store the instrument in a dry area.
3. Large force, or sharp objects may damage the screen.
4. It is recommended to use the original power adapter with the instrument.
5. To ensure that the instrument works properly, please do not store, or use the instrument in places that are too hot or too cold; please do not put the machine in damp locations, or directly under sunlight. Do not use the instrument in severe environment such as strong shock or quake.
6. Check battery before usage.
7. Please avoid strong electromagnetic interference in usage.
8. Please do not use the instrument to measure surfaces that are not flat.
9. Please keep the instrument steady; do not shake the instrument in usage.
10. Please put the instrument directly on the spot to be measured, but do not apply strong force.
11. If this user manual is further updated, we are not obliged to notify you.
12. If any questions, please contact us directly.

## Instrument functions

1. To test multiple color parameters:  
 $\Delta E^*ab, \Delta E^*ch, \Delta E^*uv, \Delta E^*cmc(2:1), \Delta E^*cmc(1:1), \Delta E^*94, \Delta E^*00, \Delta Eab(\text{Hunter}), 555, \text{color classification}, CIE-L^*a^*b^*, L^*C^*h, L^*u^*v, XYZ, Yxy, \text{Hunter-lab}, \text{Munsell MI}, \text{CMYK}$
2. Large data storage space;
3. TFT display screen;
4. Friendly man-machine interactive interface;
5. LED light source, and possess longer service life;
6. Low power consumption design, high capacity rechargeable lithium-ion battery configuration;
7. Low battery prompt function; full data space prompt function;
8. USB data transfer, PC color QC software;
9. Be able to connect with the mini-printer for printing.

## Technical Parameters

Model	CS-600C	CS-600CG
Function	color	color and gloss
Geometry	45/0	
Aperture	11mm	
Wavelength	400-700nm	
Wavelength Interval	10nm	
Sensor	high sensitivity silicon photodiode	
Illumination	LED	
Repeatability	Reflectance: standard deviation within 0.08% Chromaticity value: $\Delta E^*ab$ 0.03 (when a white plate is measured 30 times at 5 second interval), Maximum 0.05	
Inter Instrument Agreement	$\Delta E^*ab$ 0.2 Within (BCRA II color tiles, average test value of 12 tiles)	
Language	Chinese and English	
Observer	2°/ 10°	
Illuminants	A, C, D50, D55, D65, D75, F1~F12, CWF, U30, DLF, NBF, TL83, TL84, U35	
Color Space	CIE-L*a*b, L*C*h, L*u*v, XYZ, Yxy, Reflectance, Hunter-lab, Munsell MI, CMYK	
Index	WI (ASTM E313-00, ASTM E313-73, CIE/ISO, AATCC, Hunter, Taube Berger Stensby), YI (ASTM D1925, ASTM E313-00, ASTM E313-73), Tint (ASTM E313, CIE, Ganz), Metamerism index Milm, Stick color fastness, Color fastness, ISO brightness, A density, T density, M density, E density	

Color Difference	$\Delta E^*ab, \Delta E^*CH, \Delta E^*uv, \Delta E^*cmc(2:1), \Delta E^*cmc(1:1), \Delta E^*94, \Delta E^*00, \Delta Eab$ (Hunter), 555 shade sort	
Test Angle	60°	
Test Area	5x10 mm	
Test Range	0-1000 GU	
Repeatability	0.2 GU(0-100GU) 0.2%(100-1000GU)	
Reproducibility	1.0 GU(0-100GU) 1.0%(100-1000GU)	
Illumination Life Time	10 years 3million test	
Screen	2.8 inch color screen	
Storage	20000 samples	
Interface	USB	
Power	rechargeable Lithium Battery, continuous measurement 20000 times, 7.4V/600mAh	
Work Condition	0-45 relative humidity 80% or less (at 35 ) with no condensation	
Size	350*300*200mm(L*W*H)	
Weight	about 800g (without battery)	
Standard accessories	AC adapter, Lithium Battery, operate manual, color QC software, driver software, USB cable, Calibration tile (Black and white), carrying bag Gloss calibration tile	

- ① Test indicator light
- ② Display screen
- ③ Save
- ④ Cancel / Back
- ⑤ Up / down
- ⑥ Enter
- ⑦ Menu
- ⑧ Printing /Camera
- ⑨ Measurement slot
- ⑩ Measurement panel
- ⑪ Battery lid

## Appearance and structure

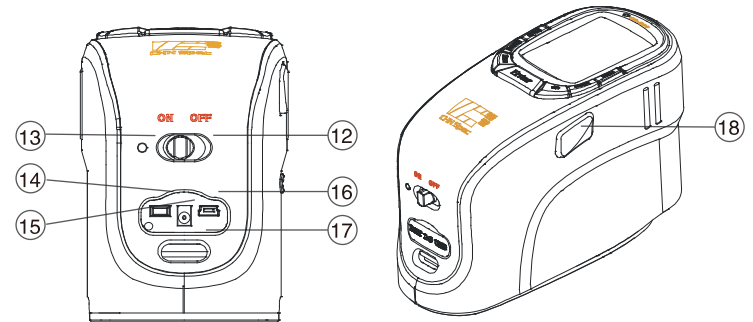
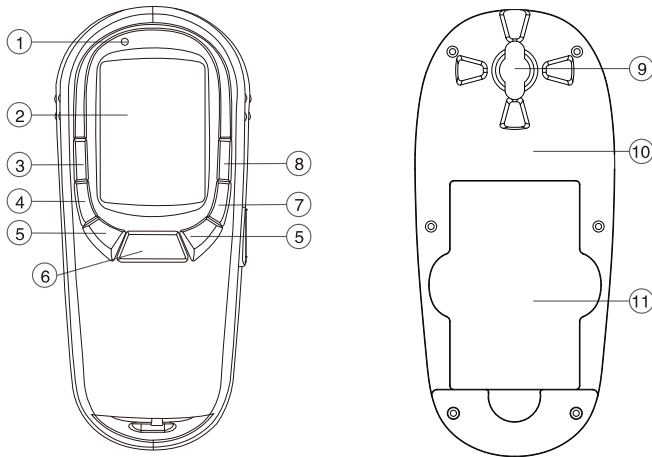

- ⑫ On & Off
- ⑬ Power indicator
- ⑭ Micro-printer interface
- ⑮ DC adapter socket
- ⑯ USB interface
- ⑰ Rope groove
- ⑱ Test

## Measurement flow chart

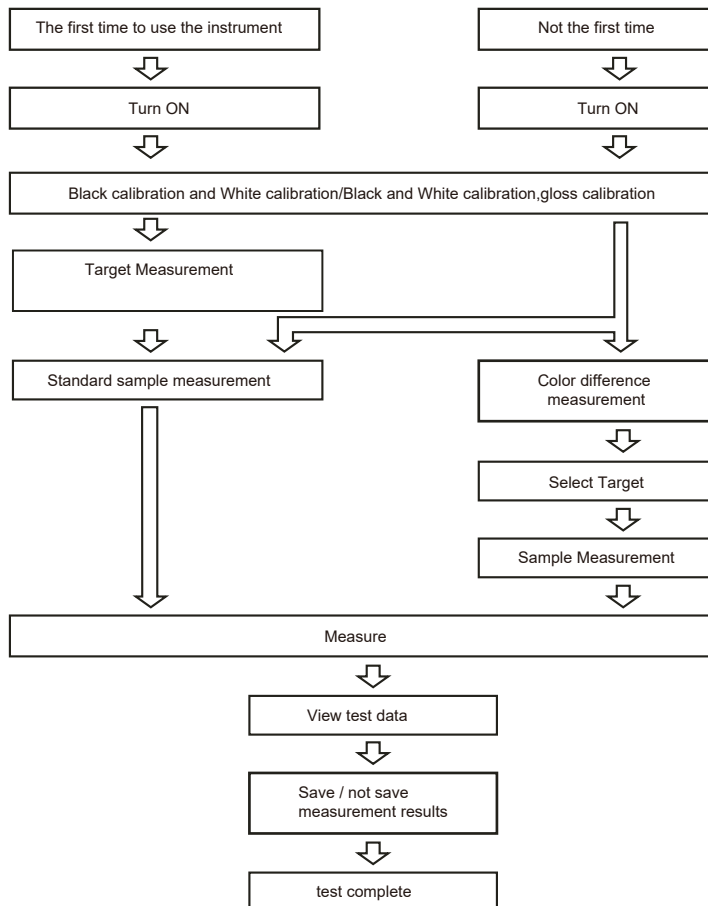

## Program interface

A-1

Main interface

① Title area: display primary functions of the current page

② Working area: display primary functions of sub-pages of current page, or measurement data

③ Condition area: display current conditions of the current page

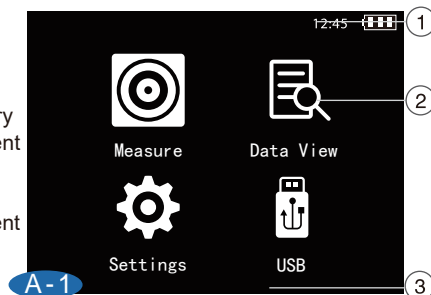

Basic operations:

Use up or down buttons to select the function, then press “Enter” to enter that function’s sub-page; press “Cancel” to return to the previous page, “Save” to save measurement data or system settings; “Menu” to show the menu, “Print” to print measurement data or call out camera view.

Measurement: the user can measure the color values of the sample, color differences, and view saved measurement data;

Data view: in this page the user can view the measurement data under saved target, and can view, delete or edit the name of selected sample;

Settings: user can change the measurement and system settings under this page;

USB user can use the USB cable to connect the instrument to with PC.

## Measurement

In the main page, use up and down buttons to select “measure”, and press “Enter” to enter the measurement page.

Under this page, user can measure the sample’s color values, reflectance and so on; and can measure the color difference between two samples and compare their reflectance figure.

## Target measurement

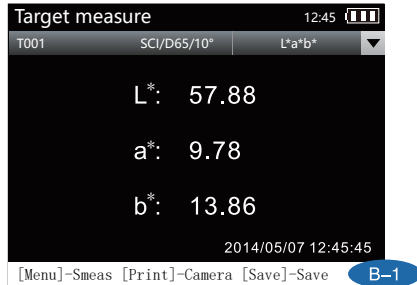

**B-1**

Press “print” to view the area being measured, then press the “Test” . In the title of the measurement results, first column is target name, after pressing “save” to save, it will show the saved name; before being saved, target’s default name would be “Txxx”.

Second column shows measurement conditions, is such as, light source ,observe angle and test mode, all of which can be changed in the “settings” page. The third column includes data that can be viewed; press “Enter” to view the reflectance value and figure of the selected data.

When viewing reflectance, press “Up” and “Down” to see reflectance value at different wavelengths.

## Sample measurement

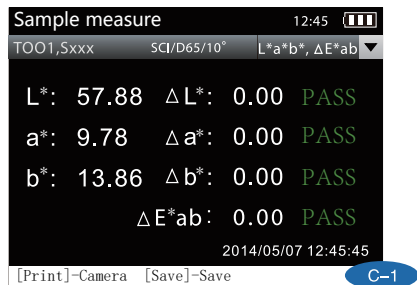

**C-1**

After measure and save at least one target, press “Menu” to enter the sample measurement page under this target. Press “Test” to measure the color difference; which is same as measuring target, after pressing “save” to save, it will show the saved name; before being saved, sample’s default name would be “Sxxx”.

Sample test can also be done under data view page. Press “Up” and “Down” to select a target, and press “Test” to measure the color difference.

Note: please set the tolerance before measurement;

On sample measurement page, press “Enter”, and then you can select reflectance with “Up” and “Down”.

## Data View

**D-1**

In the main page, use “Up” or “Down” to select “Data View”, press enter to enter the data view page, and view saved target.

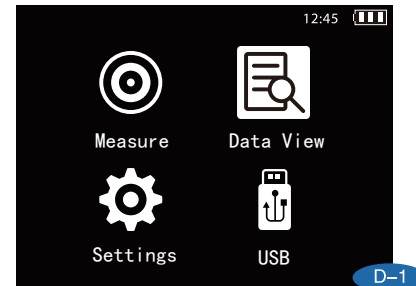

### D-2

Use “Up” or “Down” to select the target, then press “Enter” to view the measurement results of selected target.

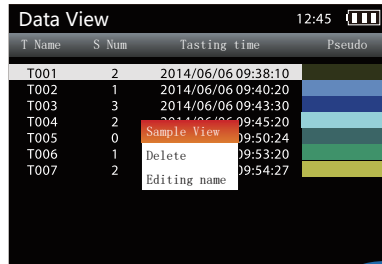

[Enter]-Target View [Menu]-Menu

D-2

### D-3

Use “Up” or “Down” to select the target, then press “Menu” to open a menu, in which you can view or delete a standard sample, or change its name. Delete will also delete all test samples under the target.

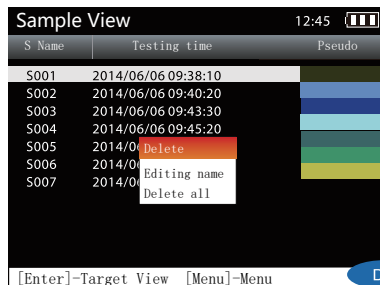

[Enter]-Target View [Menu]-Menu

D-3

## Settings

In the main page, use up and down buttons to select “Settings”, and press “Enter” to enter the settings page.

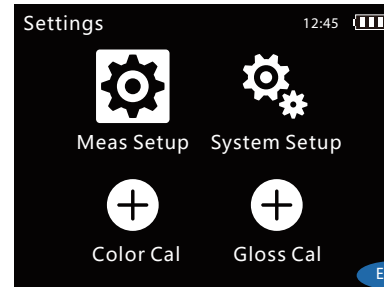

E-1/1

E-1/1

**Measure Setup:** the user can change settings of light source, spectator, tolerance.

**System settings:** user can set language, time and power do factory reset, and check the version of the instrument.

**Color calibration:** In the page, the user can perform color calibration.

**Gloss calibration:** In the page, the user can perform gloss calibration.

## Measurement setup

E-2/1

Use “Up” and “Down” to select; press “Enter” to enter measurement setup page.

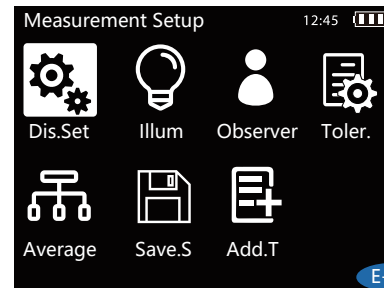

E-2/1

E-3/1

Display settings: “Up”/ “Down” to select; “Enter” to enter display settings page. Press “Up” and “Down”, select the color space and confirm with “Enter”. Then, the measurement page would show the values you need.

Note: after selection “Metamerism”, you can set the observer and light source for metamerism comparisons.

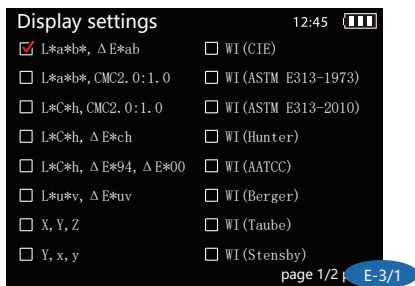

E-5/1

Observer: Use “Up” or “Down” to select; press “Enter” to enter observer settings page.

The instrument offers two angles: 2° and 10°. Select with “Up” or “Down”.

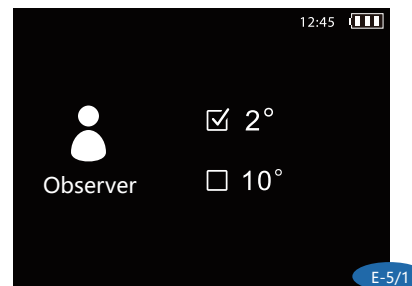

E-4/1

Light source: Use “Up” and “Down” to select; press “Enter” to enter light source selection page. Under this page, you can choose any light source, including A, C, D50,D55, D65, D75, F1, F2, F3, F4, F5, F6, F7, F8, F9, F10, F11, F12, CWF, U30, DLF, NBF, TL83 and TL84 light sources, which is a total of 24 light sources. Use “Up”, “Down” and “Enter” to confirm your choice.

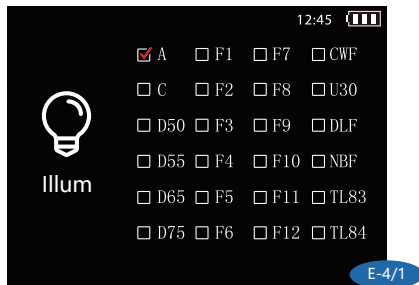

E-6/1

Tolerance settings: Use “Up” or “Down” to select; press “Enter” to enter tolerance settings page. Use “Up” or “Down” to set the values and press “Enter” to confirm.

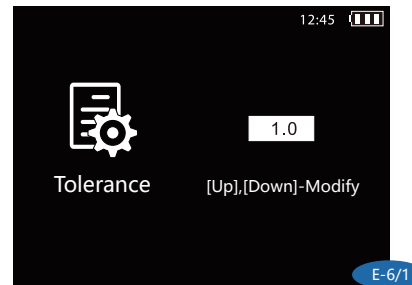

E-7/1

Average: Use “Up” and “Down” to select; press “Enter” to enter average settings page. In this page, the user can set how many measurement for average. Use “Up” and “Down” to set the values and press “Enter” to confirm.

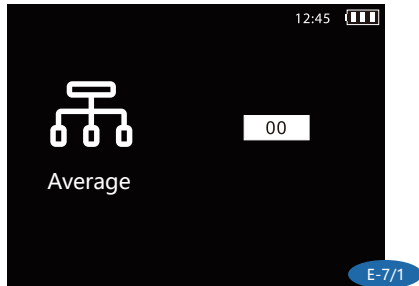

E-7/1

E-9/1

Save setting: Use “Up” and “Down” to select; press “Enter” to enter “Save.S” page. Use “Up” and “Down” to select “Manual save” or “Auto Save”, press “Enter” to confirm.

Auto Save: the target and sample measurement will be automatically saved and named every time (T040、S001).

Manual Save: the target and sample measurement will be saved and named by the user (such as Txxx、Sxxx) .

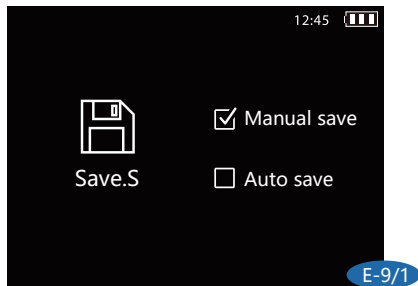

E-9/1

E-10/1

Add Target : Use “Up” and “Down” to select; press “Enter” to enter “Add.T”page. Press “Up”、 “Down” and “Enter” , select the color space and enter the vale you need. Use “Up” and “Down” to choose “Add” and press “Enter” to confirm. After saving, simulation area can show the target color you added

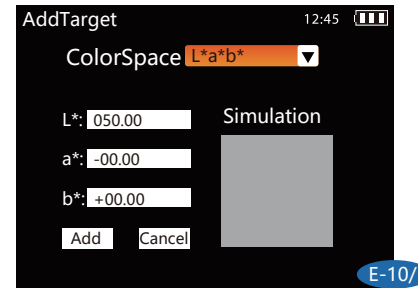

E-10/1

## System setup

F-1/1

Use “Up” and “Down” to select; press “Enter” to enter system setup page. In the system setup page, you can enter these sub-pages: settings for language, time, power, reset all and version.



F-1/1

F-2/1

Language selection: Use “Up” and “Down” to select; press “Enter” to enter language selection page. Use “Up” and “Down” to choose language: Chinese or English.

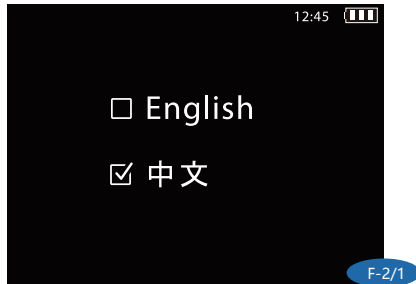

F-4/1

Power: Use “Up” and “Down” to select; press “Enter” to enter power settings page. Use “Up” and “Down” to set lighting time and power off time. Use “Up” and “Down” to select the value you want to change and press “Enter”; then use “Up” and “Down” to set the value, press “Enter” to confirm. Finally, press “Cancel” to save the values or exit time setting.

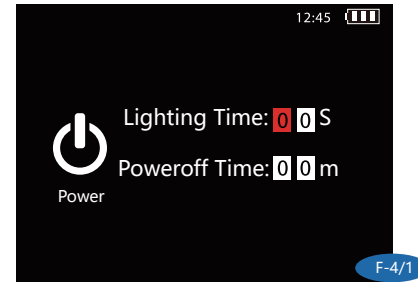

F-3/1

Time setting: Use “Up” and “Down” to select; press “Enter” to enter time settings page. Use “Up” and “Down” to select the value you want to change and press “Enter”; then use “Up” and “Down” to set the value, press “Enter” to confirm. Finally, press “Cancel” to save the values or exit time setting.

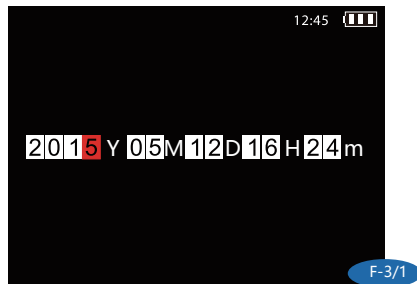

F-5/1

Reset All: Use “Up” and “Down” to select; press “Enter” to enter reset all page. This action will delete all data and restore all to default settings.

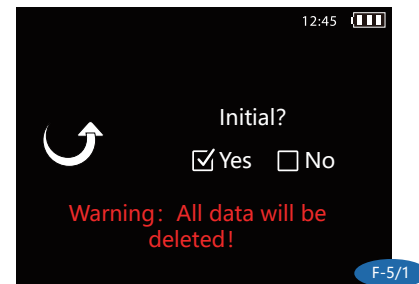

F-6/1

Version: Use "Up" and "Down" to select; press "Enter" to enter version page. In this page you can view the instrument's model, serial number, software version and company name.

(Note: the software version may be subjected to change without notice)

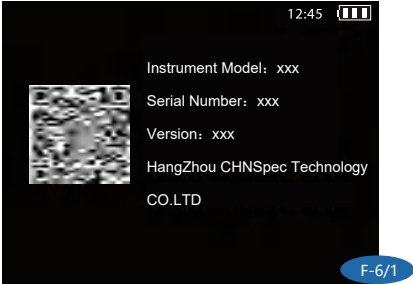

## Gloss calibration

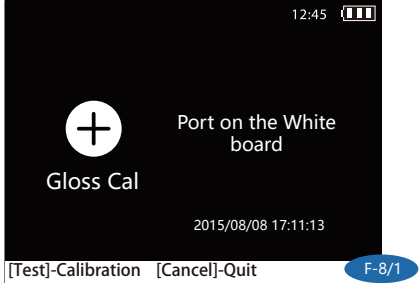

F-8/1

Put the instrument on gloss calibration tile. Press "Enter" to calibrate. Calibration is finished after the short "Beep" sound.

## Color calibration

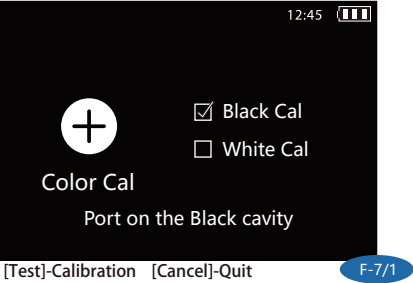

F-7/1

Put the measurement on the black cavity, press "Enter" to calibrate; then press "Cancel". After black calibration, then put the instrument on standard white tile, Press "Enter" to calibrate.

Calibration is finished after the short "Beep" sound.

## USB

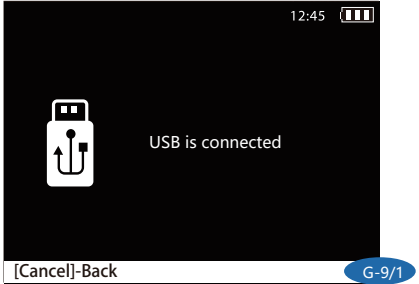

G-1/1

In the main page, Use “Up” and “Down” to select; press “Enter” to enter USB page.

Use the USB cable provided with the instrument to connect the instrument to PC. Install the driver program as instructed (driver program is in the CD provided with the instrument). The USB will be connected correctly after the driver program is installed, as shown in the above picture.



G-1/2

After entering the USB connection page, if USB is not connected, or connected unsuccessfully, the page will be shown in the above picture. Use the USB cable to connect again.

## Standard accessories

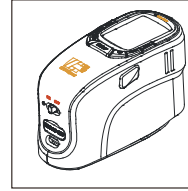

Main instrument

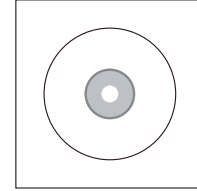

software CD

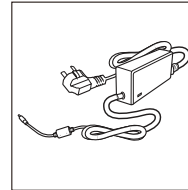

Power adapter

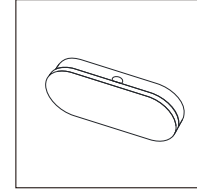

Black/white calibration box

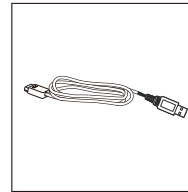

USB cable

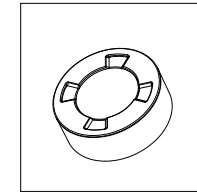

Gloss calibration tile  
(Belong to CS-600CG)

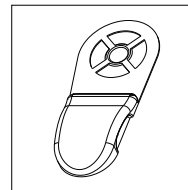

Positioning board  
(Optional Accessories)

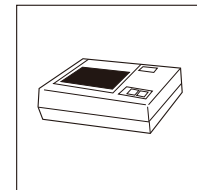

Mini-printer(optional)

## System deployment diagram

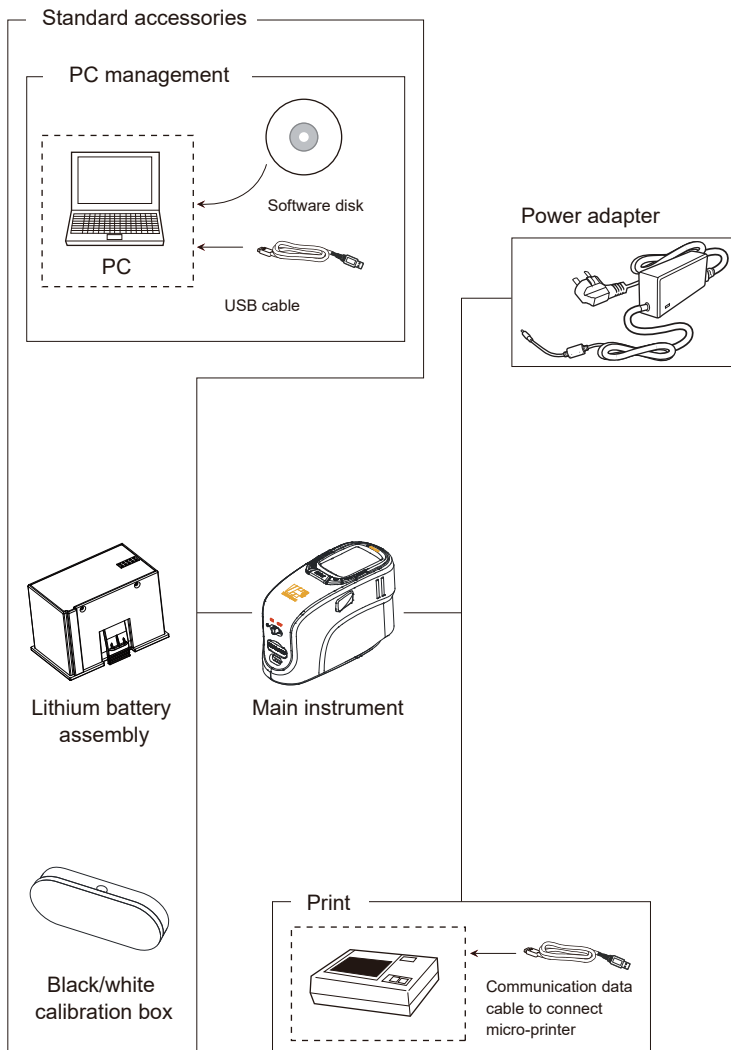

## Trouble Shooting

Error	Analysis	Handling
1. Instrument can not switch on	1. Check battery or power adapter 2. Check battery power	Install battery or connect power adapter to outside power source
2. Unable to enter main program processes after switch on	1. Check if the instrument is calibrated 2. Check if there are errors during calibration	Calibrate again, and then enter the main program
3. Exception in measurement results	Check if the tolerance setting is reasonable	Check and change tolerance settings
4. Unreasonable measurement results	1. Check if the instrument is lying stably on a flat sample 2. Check if the sample is too thin 3. Check if there are multiple colors in the test area	1. Make sure instrument is lying flat 2. Put a thick piece of white paper under sample 3. Only check single color
5. Large difference between two measurements	Check if the battery is under 20%	Use power adapter

## Testing Result Analysis

▼  $\Delta E$  Color Difference Scale  $\Delta E^*ab = \sqrt{(\Delta L^*)^2 + (\Delta a^*)^2 + (\Delta b^*)^2}$

L+ represents white, L- represents black, a+ represents red, a- represents green, b+ represents yellow, b- represents blue. When we use CIE-L\*a\*b\* to show a color, L\* is black or white, a\* is red or green, b\* is yellow or blue.

▼ CIE LAB

CIE LAB is color space based on the fact that a color can't be both red and green, or both blue and yellow, because these colors oppose each other. So a single data could be used to describe red/green and yellow/blue. When we use CIE L\*a\*b\* to describe a color, L\* means lightness, a\* means red/green and b\* means yellow/blue.

▼ CIE LCH

CIE LCH adopts same color space as L\*a\*b\*, but its L\* represents lightness, c\* represents saturation and h\* represents hue.

## Company's statement

- 1.The company promises that our spectrophotometer offers one year of warranty after purchase date. Non-artificial damage under normal use is subjected to free warranty. The company offers repair services for artificial damage, or damage after the warranty time limit; however, the repair services would require fees relative to the damage.
- 2.The warranty only holds for the person, or company who purchased the instrument. Damage occurring under third party usage would not be eligible for warranty service.
- 3.The company is not responsible for data loss because of error, repairing, or power outages. To prevent loss of important data, please save copies of the data on your PC.
- 4.The copyright ownership of the instrument and its associated software belong to our company and is protected by the Copyright Laws of People's Republic of China.
- 5.Our company sells the instrument does not mean we transfer the copyright, or any intellectual property's ownership to the user.
- 6.The specifications and information in this manual are subjected to further updates without notice.