

使用说明书

Operate Manual

目录 CATALOGUE

[一]使用须知	01
[二]注意事项	02
[三]功能描述	03
[四]技术参数	04
[五]外观结构介绍	05
[六]测量流程图	06
[七]软件界面介绍	08
7.1 功能介绍	08
7.2 登陆	10
7.3 向导	13
7.4 校准	19
7.5 测量	22
7.6 设置	24
7.7 数据浏览	31

7.8 个人中心	36
7.9 关于	37
7.10 日志	38
7.11 更新	39
[八]测量界面介绍	40
8.1 雾度/透过率/清晰度	40
8.2 雾度/透过率	41
8.3 雾度	42
8.4 透过率	43
8.5 清晰度	44
8.6 色差	45
8.7 数据	51
8.8 图形	52
8.9 同色异谱	58
8.10 液体色度	59
[九]参数介绍	60
[十]异常处理分析	64
[十一]附件	65
[十二]公司声明	67

使用须知

- 1、本机是一台设计用于测定塑料、薄膜、玻璃制品、LCD面板等透明、半透明平行平面材料的雾度、总透光率、光谱透射性能的仪器。
- 2、本机广泛应用于实验室、工厂、或现场操作，足以在几乎所有应用领域的质量控制中实现最佳的雾度、颜色测量。
- 3、限制性保修的时间段是自购买本仪器开始起（时间：如一年）的时间。如果您的仪器需要服务，请将仪器带到当地的销售部联系我们来进行维修。
- 4、为了避免仪器精度受影响，请不要将仪器私自拆开。如果由于私自拆卸机器或不正确的使用而导致仪器损坏，请用户自行负责。

注意事项

- 1、本机属精密仪器，不能承受跌落导致的碰撞，使用时请放置于相对平整的地方。
- 2、本机不能防潮或抗潮，受潮或液体溅入易损坏本机。
- 3、本机的屏幕是由玻璃制成，受到异常外力或锐器的作用易损坏。
- 4、本公司建议使用原配电源适配器。
- 5、为保障本机正常工作，请不要在过冷或过热的地方存贮和使用，也勿将本机放置在潮湿或阳光长期直射的地方，更不要在强震等恶劣的环境中使用本机，以免发生意外。
- 6、本机是精密仪器，使用时请避开强电磁干扰。
- 7、为保证测量准确，测试时请保持仪器平稳，不要摇晃。
- 8、本机属精密仪器，使用完毕请将仪器关机保管。
- 9、请将仪器存放在干燥的地方。
- 10、禁止对积分球内部进行清洁。
- 11、如果仪器发生故障，请不要尝试自行修理，我们的客户服务部门会快速的为客户提供帮助。

12、本机及说明书如有进一步改进或补充，恕不另行通知。如有疑问，敬请垂询本公司。

功能描述

- 1、设计符合以下测试标准：ASTM D1003/D1044,ISO 13468/ISO 14782,JIS K 7105,JIS K 7361,JIS K 7136,GB/T 2410-2008,JJF 1303-2011；
- 2、满足CIE-A、CIE-C、CIE-D65三种标准照明光源下的雾度、全透过率与清晰度测量；
- 3、满足补偿法测试，可提供更准确的测试结果；
- 4、拥有开放式的测量区域，可以满足任意大小的样品测量；
- 5、采用7.0寸电容触摸屏，Android操作系统，拥有良好的人机交互界面；
- 6、提供专业的雾度以及透过率的测量分析软件，可以满足用户对测试数据的分析以及管理；

技术参数

光源	雾度/透过率: CIE-A,CIE-C,CIE-D65 色度指标: A,C,D50,D55,D65,D75,F1,F2,F3,F4,F5,F6,F7,F8,F9,F10,F11,F12,CMF,U30,DLF,NBF,TL83,TL84
遵循标准	ASTM D1003/D1044,ISO13468/ISO14782,JIS K 7105,JIS K 7361,JIS K 7136,GB/T 2410-08,CIE No.15,ISO 7724/1,ASTM E1164,DIN 5033 Teil7,JIS Z8722 Condition c标准
测量参数	雾度 (HAZE),透过率 (T),清晰度 (C%),光谱透过率, CIE Lab,LCh,CIE Luv,XYZ,Yxy,Hunter Lab,MunsellMI,CMYK,白度WI(ASTM E313-00, ASTM E313-73,CIE/ISO,Hunter,Taube Berger Stensby), 黄度YI(ASTM D1925,ASTM E313-00,ASTM E313-73), Tint(ASTM E313-00),同色异谱指数Milm, APHA,Pt-Co (铂钴指数),Gardner(加德纳指数),色差 ($\Delta E^*ab, \Delta E^*CH, \Delta E^*uv, \Delta E^*cmc(2:1), \Delta E^*cmc(1:1), \Delta E^*94, \Delta E^*00$)
光谱响应	CIE光谱函数Y/V (λ)
波长范围	400-700nm
波长间隔	10nm
光路结构	0/d
照明/样品孔径尺寸	18mm/25.4mm
量程	0-100%
分辨率	0.01%
重复性	雾度 < 10%, 重复性 $\leq 0.05\%$; 雾度 $\geq 10\%$, 重复性 $\leq 0.1\%$;透光率 $\leq 0.1\%$
样品大小	厚度 $\leq 145\text{mm}$
显示	7寸电容触摸屏
存储数据	海量存储
接口	USB-A,USB-B
电源	220V (自带电源线)
工作温度	5 $^{\circ}$ C-40 $^{\circ}$ C, 相对湿度80%或更低 (在35 $^{\circ}$ C下), 无水气凝结
储藏温度	-20 $^{\circ}$ C-45 $^{\circ}$ C, 相对湿度80%或更低 (在35 $^{\circ}$ C下), 无水气凝结
体积	长X宽X高: 598mmX247mmX366mm
重量	12kg
标配	PC管理软件 (Haze QC)
选配	测量夹具、雾度标准片、定制口径板

外观结构介绍

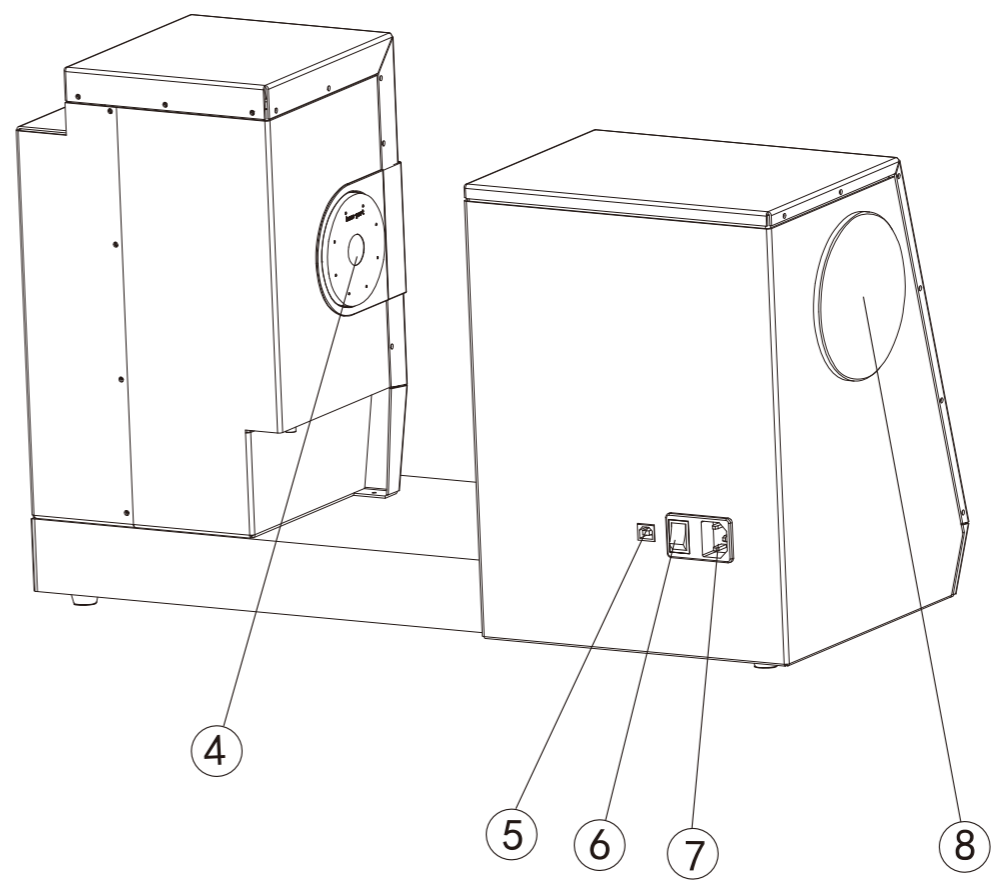
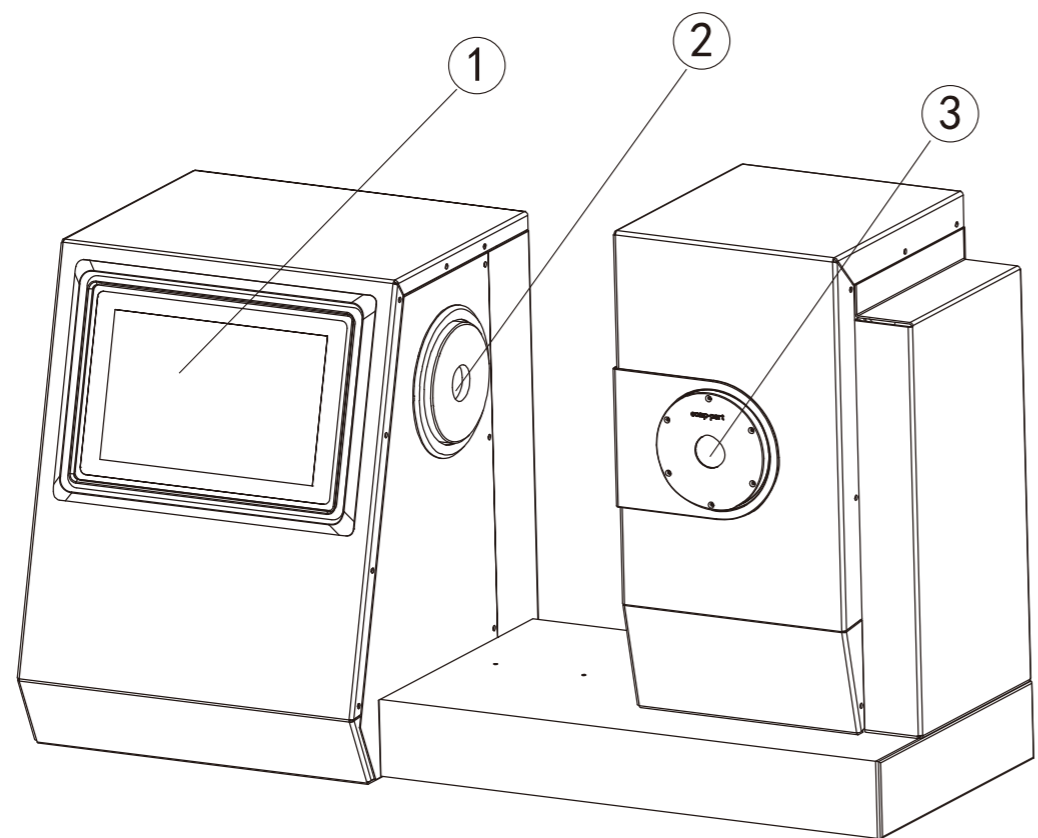

- ① 显示屏
- ② 出光口
- ③ 补偿口
- ④ 测试口
- ⑤ USB接口
- ⑥ 电源开关
- ⑦ 电源接口
- ⑧ 光源更换口

测量流程图

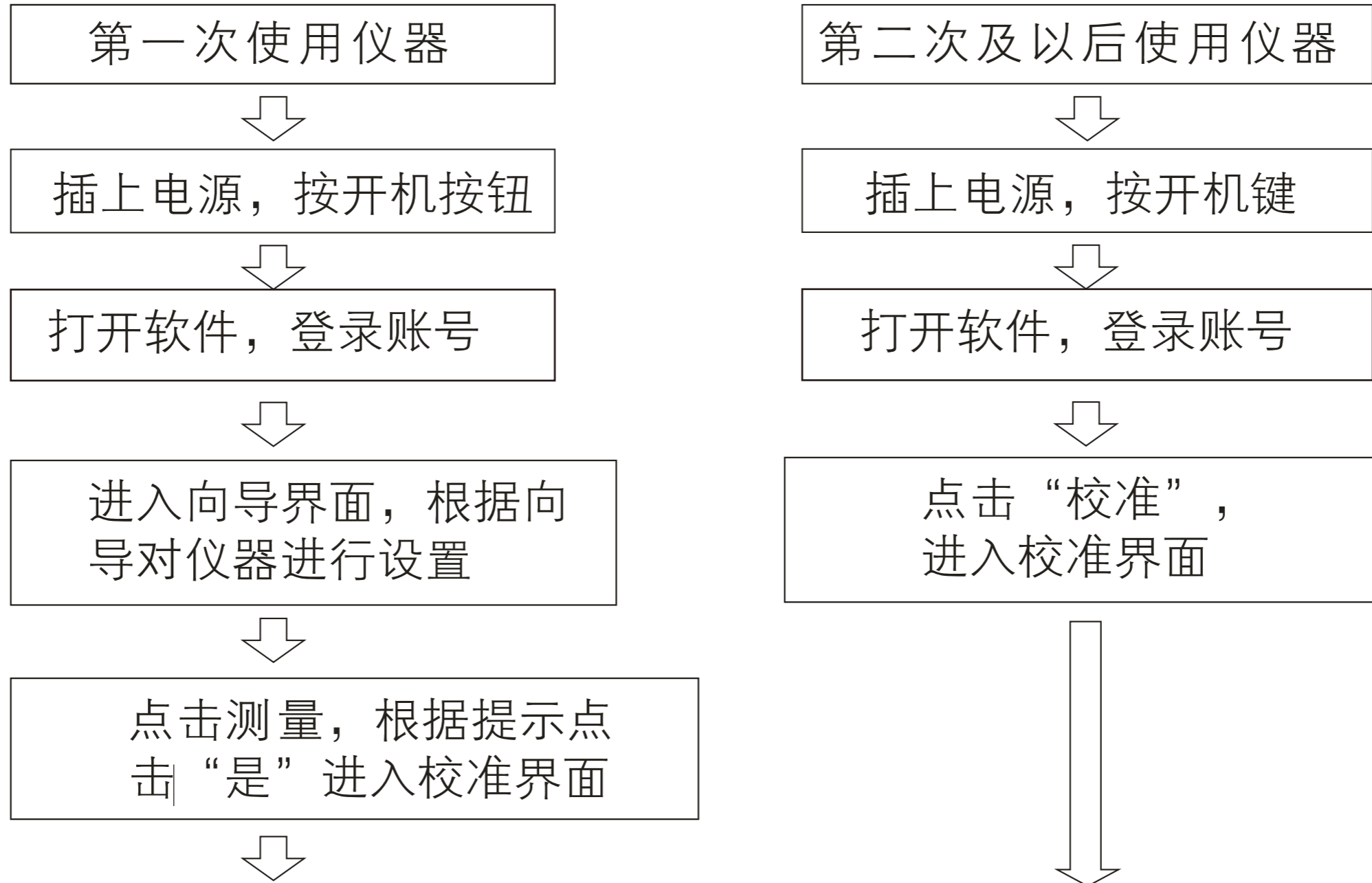

0%校准、100%校准



标样测量、试样测量



检查测量结果



保存、不保存测量结果



完成

软件界面介绍

[功能介绍]

A-1

主界面

软件分为8个模块，分别是：校准、测量、设置、数据浏览、个人中心、关于、日志、更新。

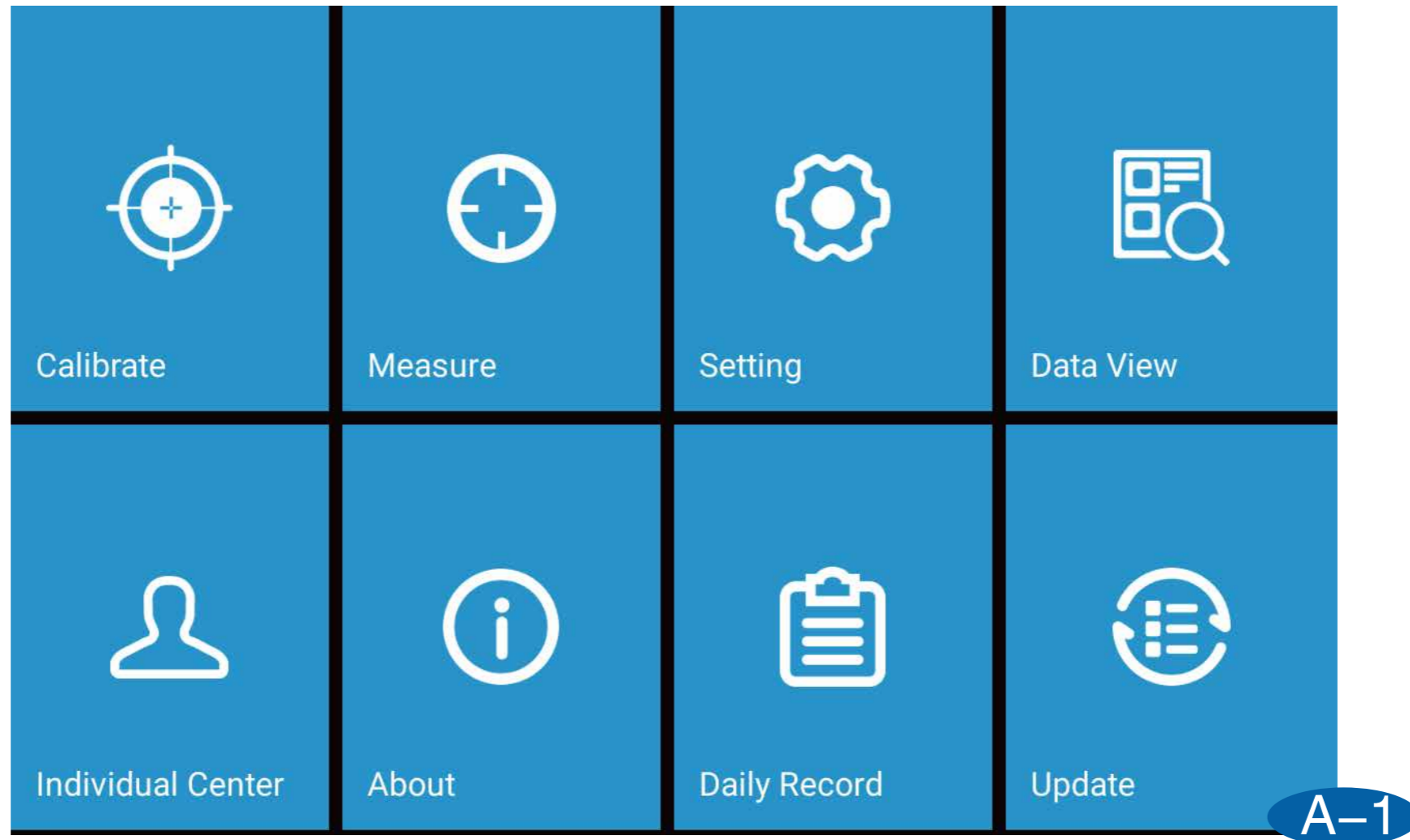

A-2

标题栏

标题栏从左到右分别为:主页按钮、测量模式、光源和观察角。

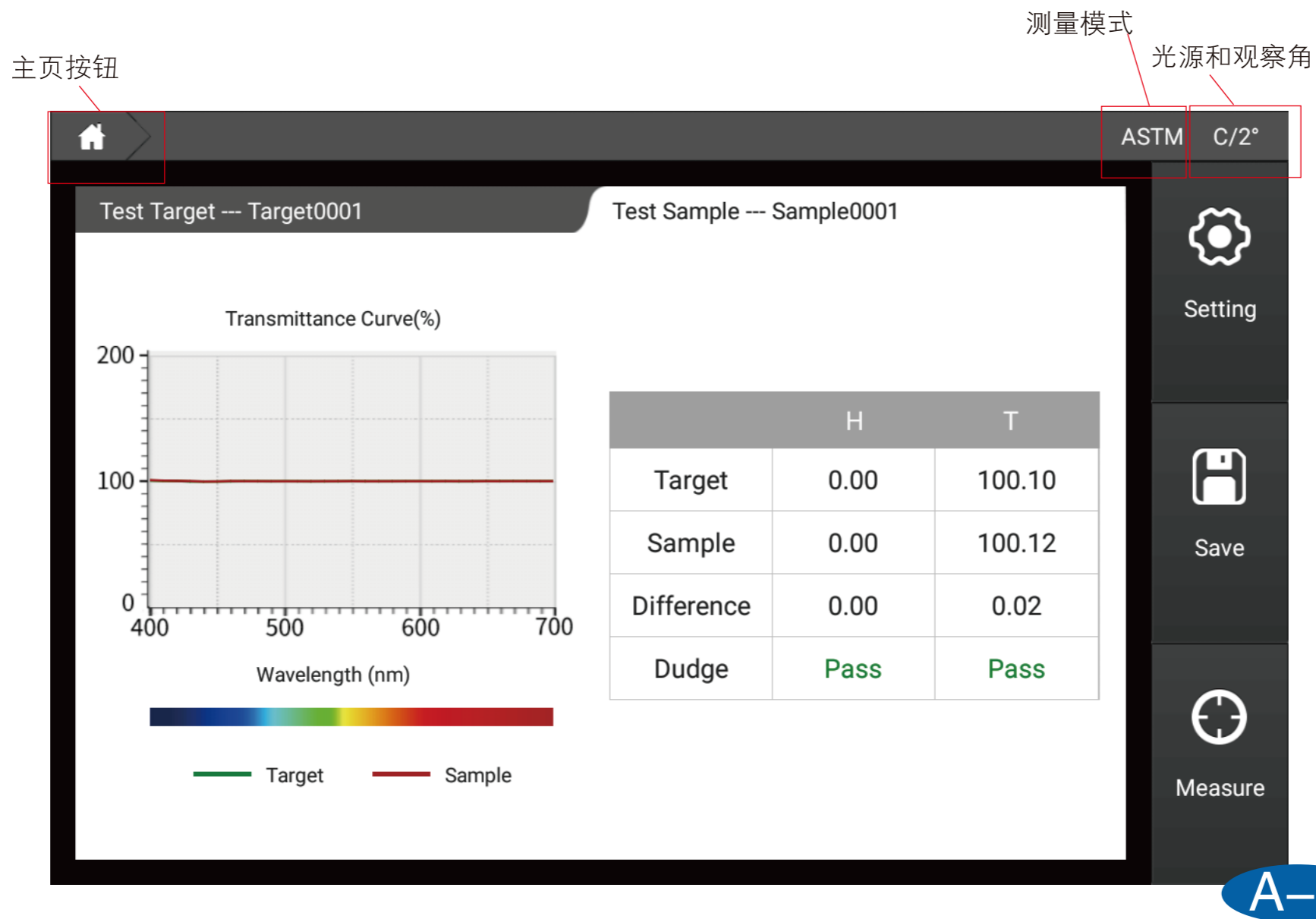

[登录]

登录分为本地登录和网络登录两种方式。勾选记住密码，下次开机时将会自动输入账户与密码，勾选自动登录下次开机将跳过登录页面，直接进入软件。

B-1

本地登录账户为：admin，密码默认为仪器序列号（登录后可以在个人中心进行修改）。
例如仪器序列号是：C81118C0128，则在登录密码处输入C81118C0128即可。

The screenshot shows a login page with a dark header. On the left, there is a 'Language' dropdown menu set to 'English'. On the right, there is a 'Wifi Setting' button. Below the header, there are two tabs: 'Login' (which is active) and 'Register'. Under the 'Login' tab, there is a 'Local Login' dropdown menu. Below that is a text input field containing the username 'admin'. The next field is a password input field with masked characters '.....'. There are two checkboxes: 'Keep Password' (checked) and 'Auto Login' (unchecked). A blue 'Login' button is positioned below the password field. At the bottom right of the login form area, there is a link that says 'Forget Password?'. A white arrow points from the 'Login' tab to the 'Local Login' dropdown.

B-1

B-2

网络登录

网络登录需要连接网络，点击注册进行账户注册，可选择邮箱或手机号进行注册。注册完成后可以使用注册的账户进行登录。使用网络登录可以将存储的数据上传到云端，可在windows端进行数据管理。

The screenshot shows a web application interface with a dark header. On the left, there is a 'Language' dropdown menu set to 'English'. On the right, there is a 'Wifi Setting' button. Below the header, there are two tabs: 'Login' and 'Register', with the 'Register' tab selected. The main content area contains two columns of input fields. The left column has fields for 'Account', 'Password', 'Confirm Password', and 'Cell Phone'. The right column has fields for 'Company Name', 'Address', 'Name', and 'Email'. At the bottom, there are three buttons: 'Input Code', 'Get Code', and 'Register'. The 'Get Code' and 'Register' buttons are highlighted in blue.

B-2

[向导]

C

第一次登录软件或恢复出厂后重新登录后，会进入仪器使用向导，可以根据向导对仪器进行设置。

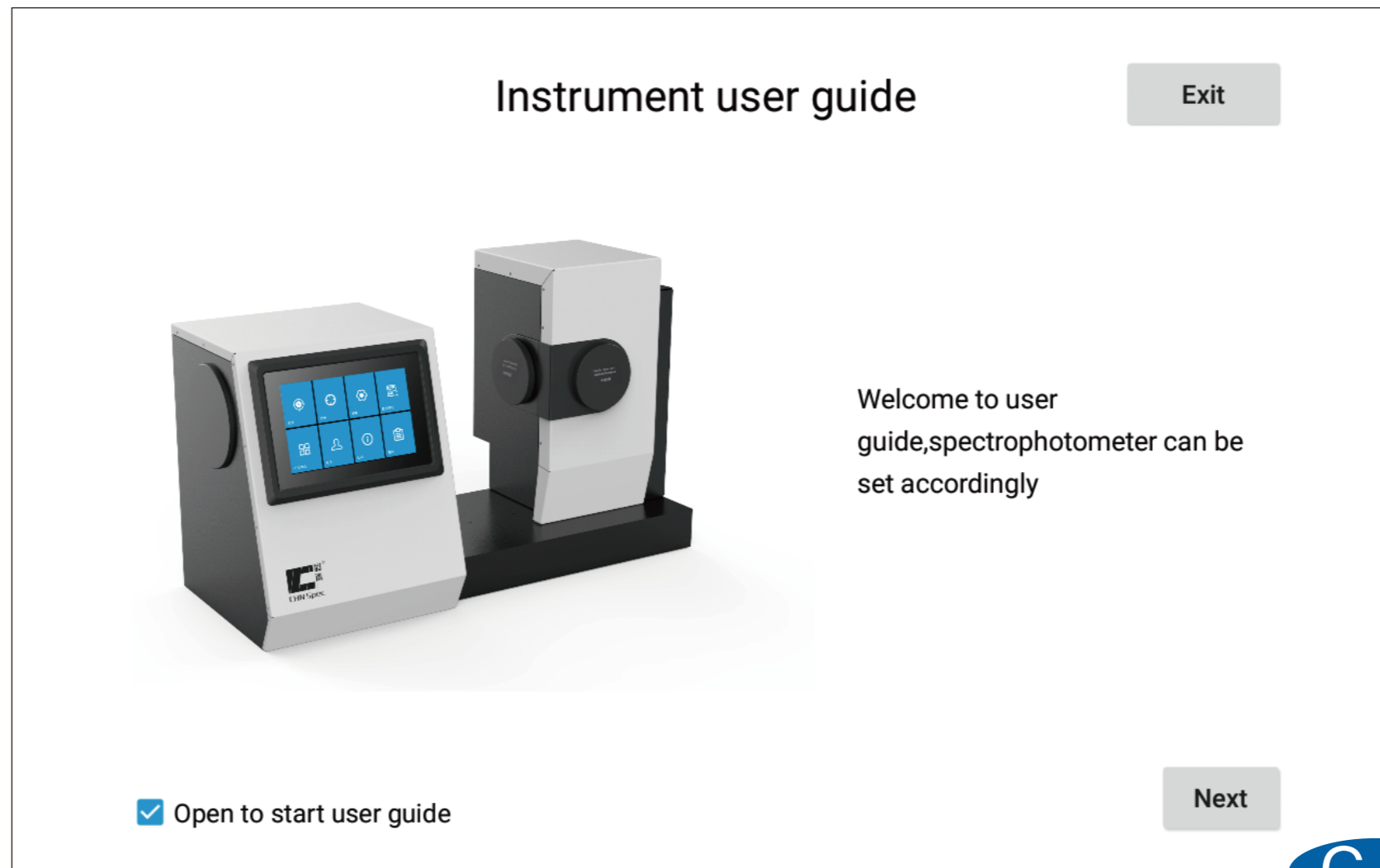

C-1

Instrument Setting

Exit

Mode Selection

ASTM

ISO

System Setting

Screen Light

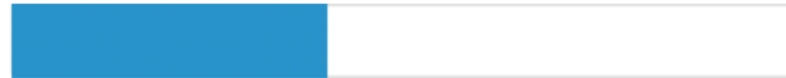

Language

English



Factory Reset

Screen Rotation

Wifi Setting

Timezone Setting

1/5

Previous

Next

C-2

Parameter Setting

Exit

Illuminant&Angle (The second illuminant is for calculating the metamerism)

First

C



2°



Second

A



2°



CMC(l:c)

l

2.0

c

1.0

CIE94

KL

1.0

KC

1.0

KH

1.0

CIE 2000

KL

1.0

KC

1.0

KH

1.0

2/5

Previous

Next

C-3

Tolerance Setting

Exit

Haze/T

CIE LAB&LCH

Hunter Lab

CIEDE2000

CIE LUV

CMC(l:c)&CIE94

Liquid

Temperature&Humidity

Haze/T

		Greater than	Less than	Between
dh(Haze) : ±	<input type="text" value="2.0"/>	<input type="button" value="Fail"/>	<input type="button" value="Fail"/>	<input type="button" value="Pass"/>
dt(T) : ±	<input type="text" value="2.0"/>	<input type="button" value="Fail"/>	<input type="button" value="Fail"/>	<input type="button" value="Pass"/>
dC : ±	<input type="text" value="2.0"/>	<input type="button" value="Fail"/>	<input type="button" value="Fail"/>	<input type="button" value="Pass"/>

3/5

Previous

Next

C-4

Other Settings

Exit

Average

Single Test Average Test

Save Setting

Manual Save Auto Save

Naming Rules

Target + Number + Date

Sample + Number + Date

4/5

Previous

Next

C-5

Display Setting

- H/T/C
- Haze/T**
- Haze
- Transmittance
- Clarity
- Color Diff.
- Data
- Figure
- Metamerism
- Liquid

5/5

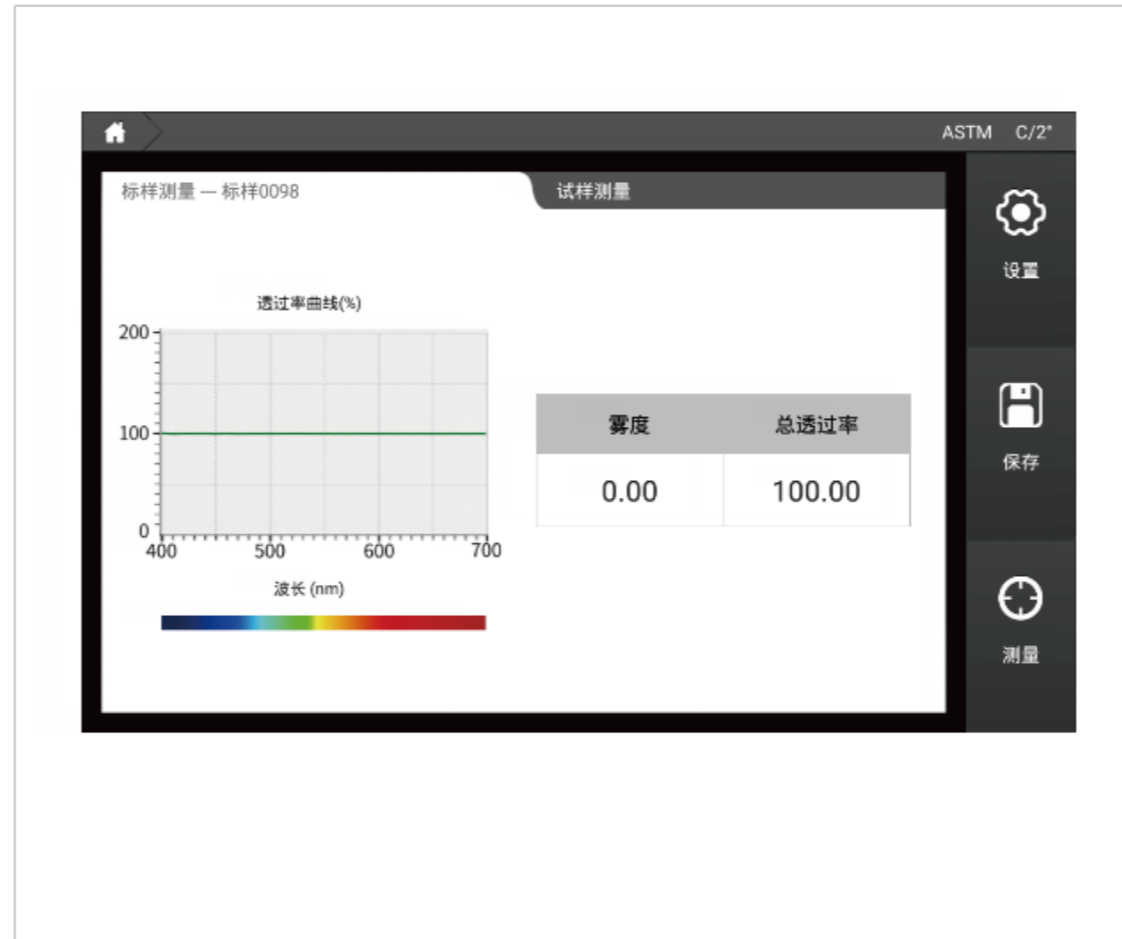

Previous

Finish

C-6

[校准]

D-1

0%校准

根据软件的提示进行0%校准。ASTM模式时，请将补偿口（comp-port）用补偿口盖盖上；ISO模式时，请保持补偿口（comp-port）处于打开状态。
该页面可以对校准有时间进行设置，默认校准有效时间为8小时。

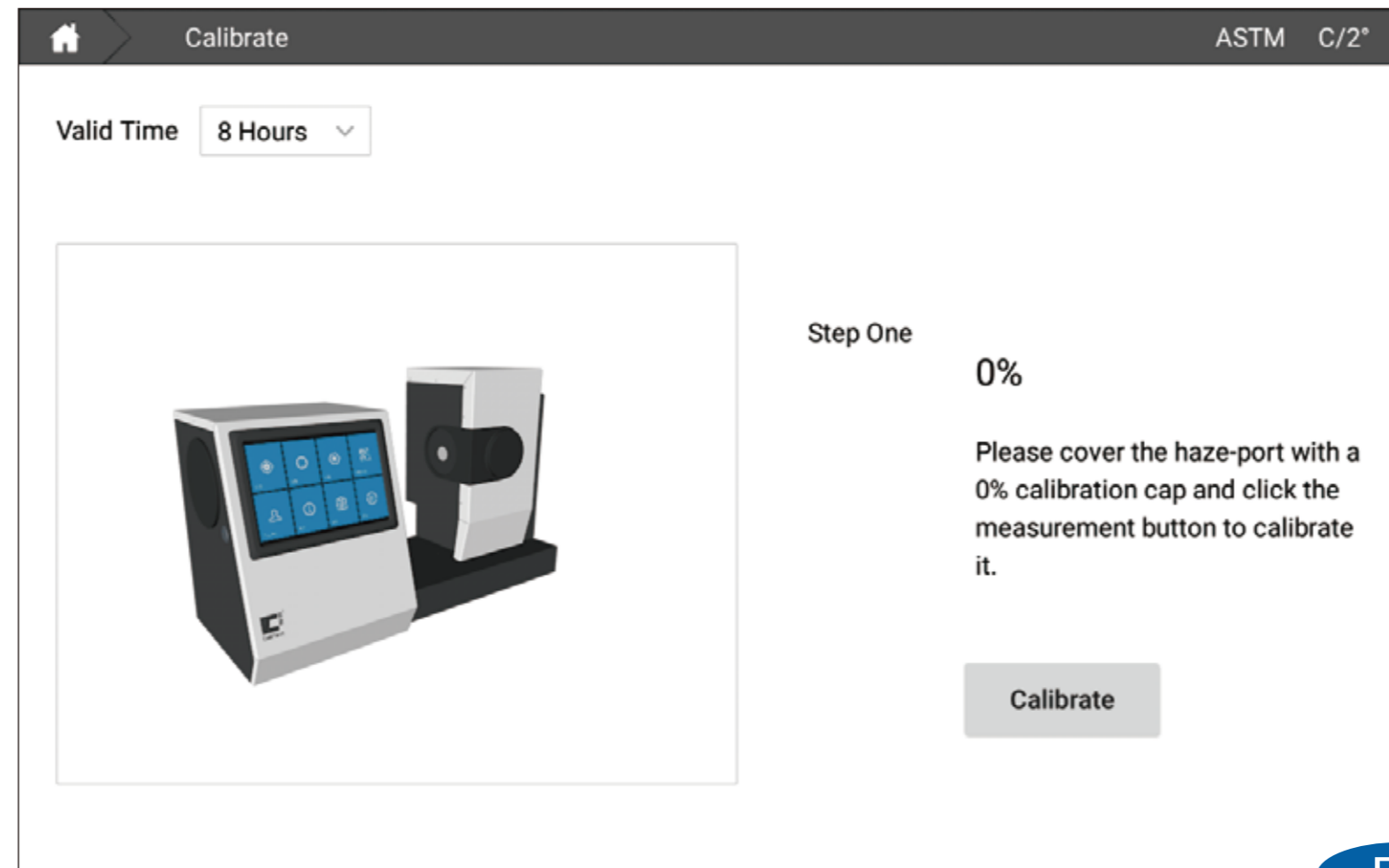

D-1

D-2

100%校准

根据软件的提示进行100%校准。

The screenshot shows a software interface for calibrating a device. At the top, there is a navigation bar with a home icon, the word "Calibrate", and "ASTM C/2°". Below this, there is a "Valid Time" dropdown menu set to "8 Hours". The main area is divided into two sections. On the left, there is an image of a device with a touchscreen and a camera. On the right, the text reads "Step Two" followed by "100%". Below this, it says "Keep haze-port aligned with the air and click the measurement button for calibration." and "0% calibration succeed" in green. At the bottom right of this section is a "Calibrate" button.

D-2

D-3

清晰度校准

根据软件的提示进行清晰度校准。

Home Calibrate ASTM C/2°

Valid Time 8 Hours

Step Three

Clarity Adjust

Please place the calibration sheet on the clarity-port and click the measurement button to calibrate the clarity

100% calibration succeed

Calibrate

D-3

[测量]

测量分为三种模式：标样测量、试样测量以及其他测量模式（同色异谱、液体色度）。

E-1

标样测量

在主页点击测量进入标样测量界面，在样品放置完成后，点击屏幕右下角测量按钮，屏幕上显示测量数据，测量按钮恢复可按压状态，表示测量完成。

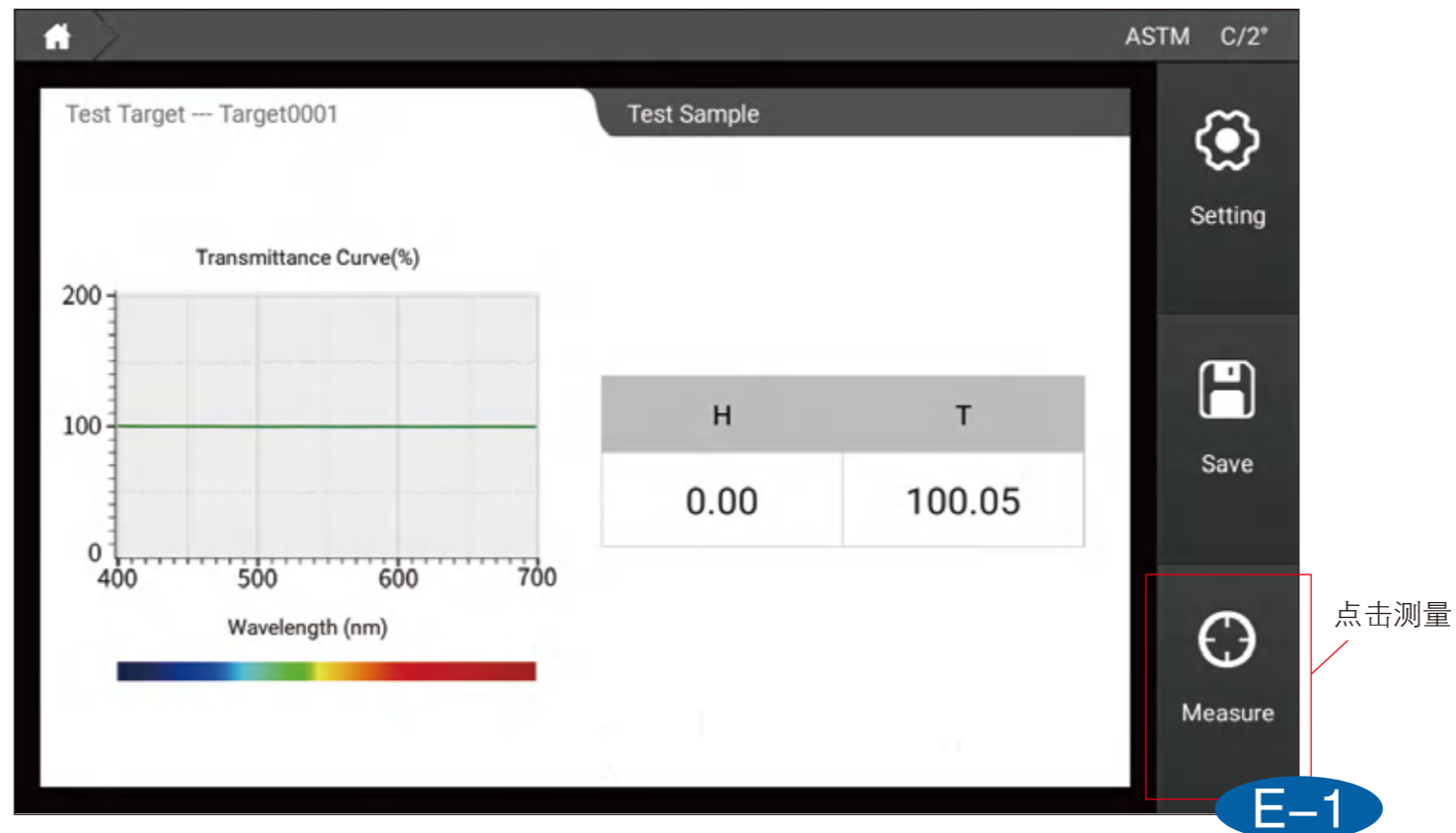

E-2

试样测量

在标样测量界面，点击界面上的试样测量，切换到试样测量界面，同样在样品放置完成后，点击屏幕右下角测量按钮，进行试样数据测量。

	H	T
Target	0.00	100.05
Sample	0.00	100.07
Difference	0.00	0.02
Dudge	Pass	Pass

Click Measure

E-2

[设置]

设置界面可以对仪器测量方式、数据计算参数、容差、软件显示、保存方式、命名规则、平均等进行配置，进行修改后需要点击“应用”按钮。

F-1

仪器设置

仪器设置分为6个区域：

- 1、雾度测量模式：可设置ASTM模式或ISO模式；
- 2、系统设置：可以设置屏幕背光以及语言切换；
- 3、恢复出厂：软件配置恢复到初始状态
- 4、屏幕旋转：点击屏幕旋转屏幕显色反向将旋转180° ；
- 5、wifi设置：可以选择WiFi并登陆；
- 6、时区设置：不同国家的时间显示，联网可自动同步时间。

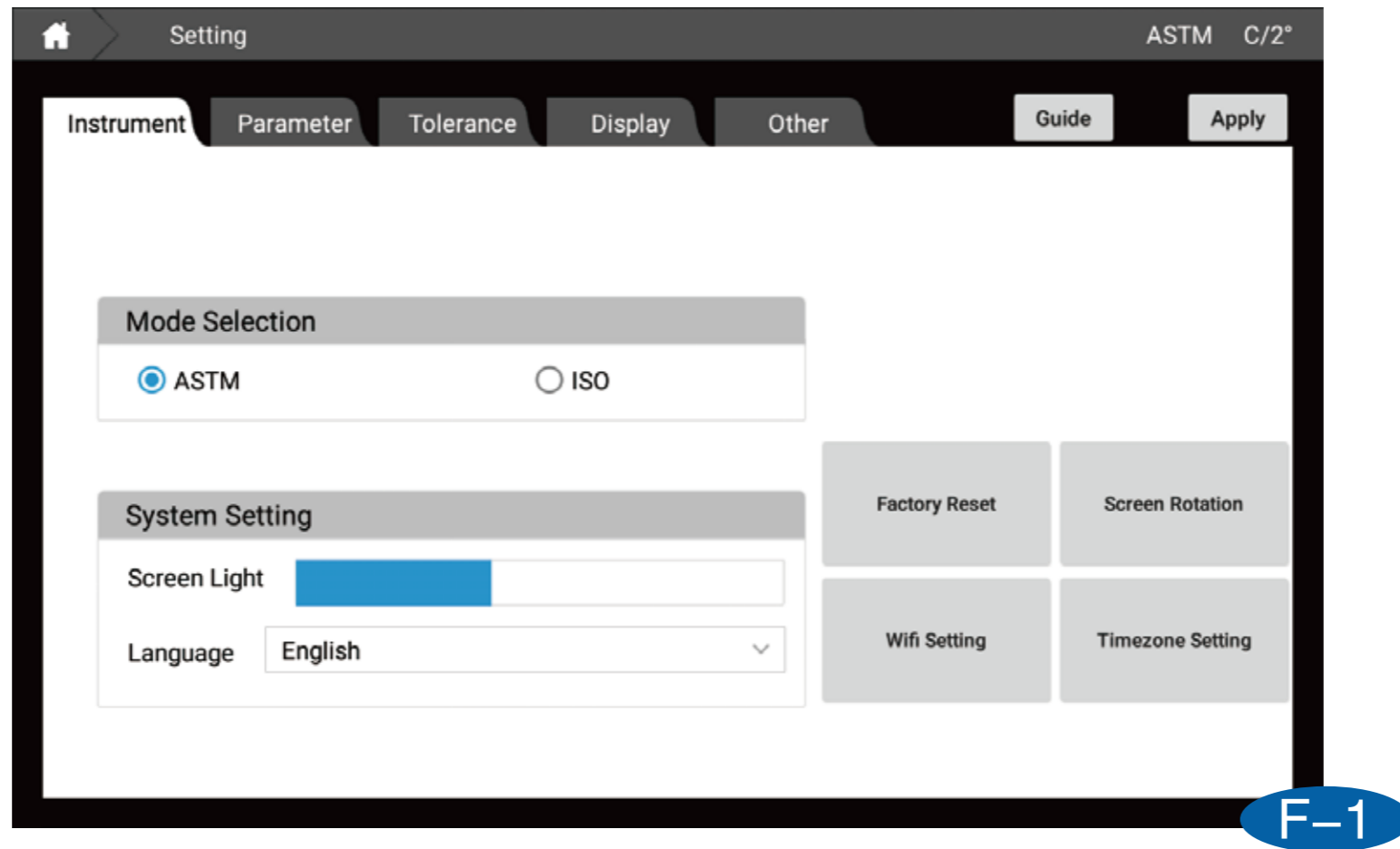

F-2

参数设置

参数设置可对数据计算进行配置

1、光源&角度：可以设置计算数据的光源与角度，第一光源与角度为所有模式下的计算数据，第二光源只用于计算同色异谱（注：相近色查找显示数据固定为D65/10°）

- 2、CMC(l:c):可以设置CMC色差公式的l:c系数;
- 3、CIE 94:可以设置CIE94色差公式的KL、KC、KH系数;
- 4、CIE 2000:可以设置CIE2000色差公式的KL、KC、KH系数;

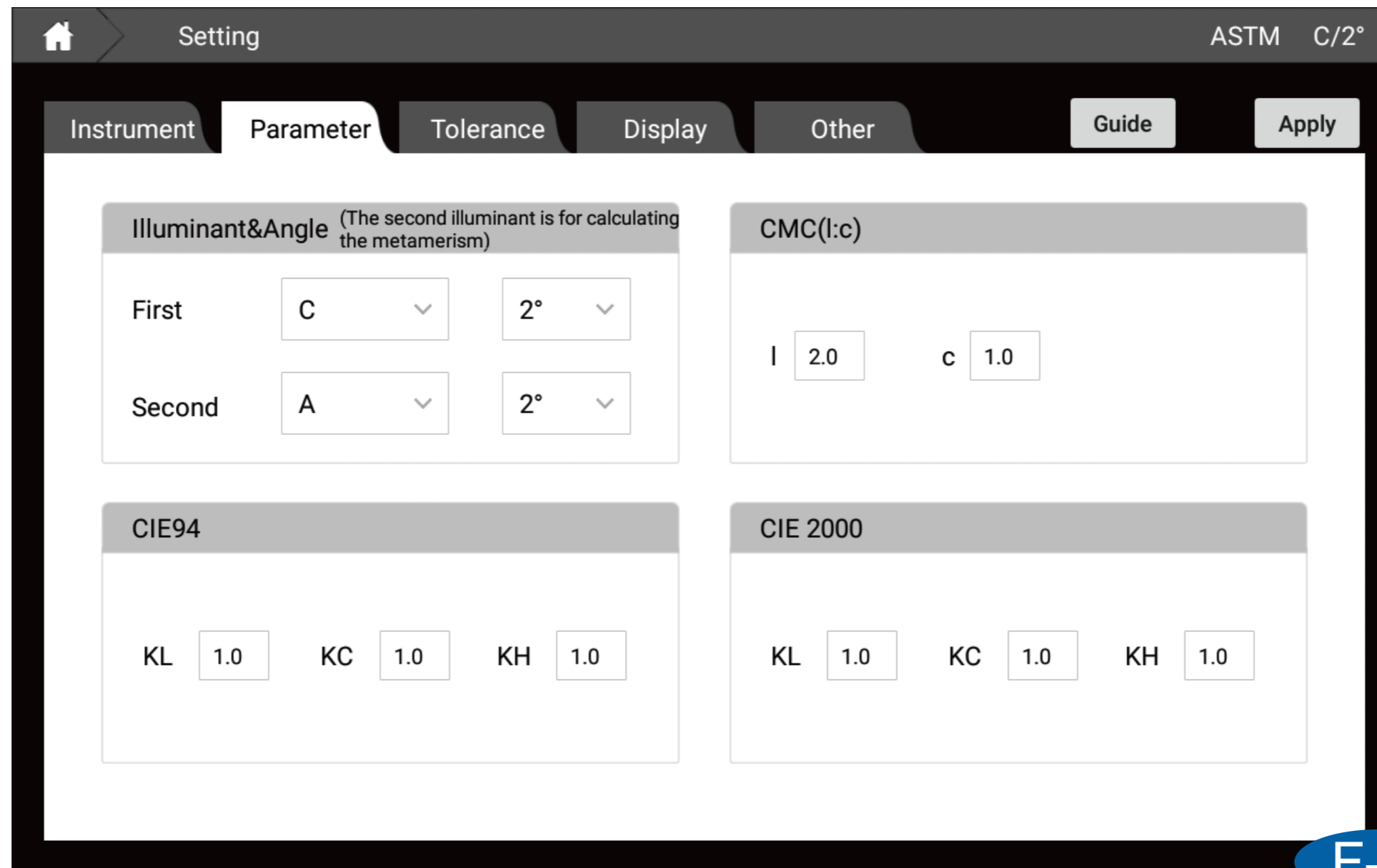

F-3

容差设置

容差用来判断测量数据是否合格的依据，当测量数据超过容差范围时将提示数据不合格，当测量数据小于等于容差时将提示数据合格。

该界面下可以设置不同色差公式以及模式的容差。（其中CIE LAB可以用户自定义提示语言）

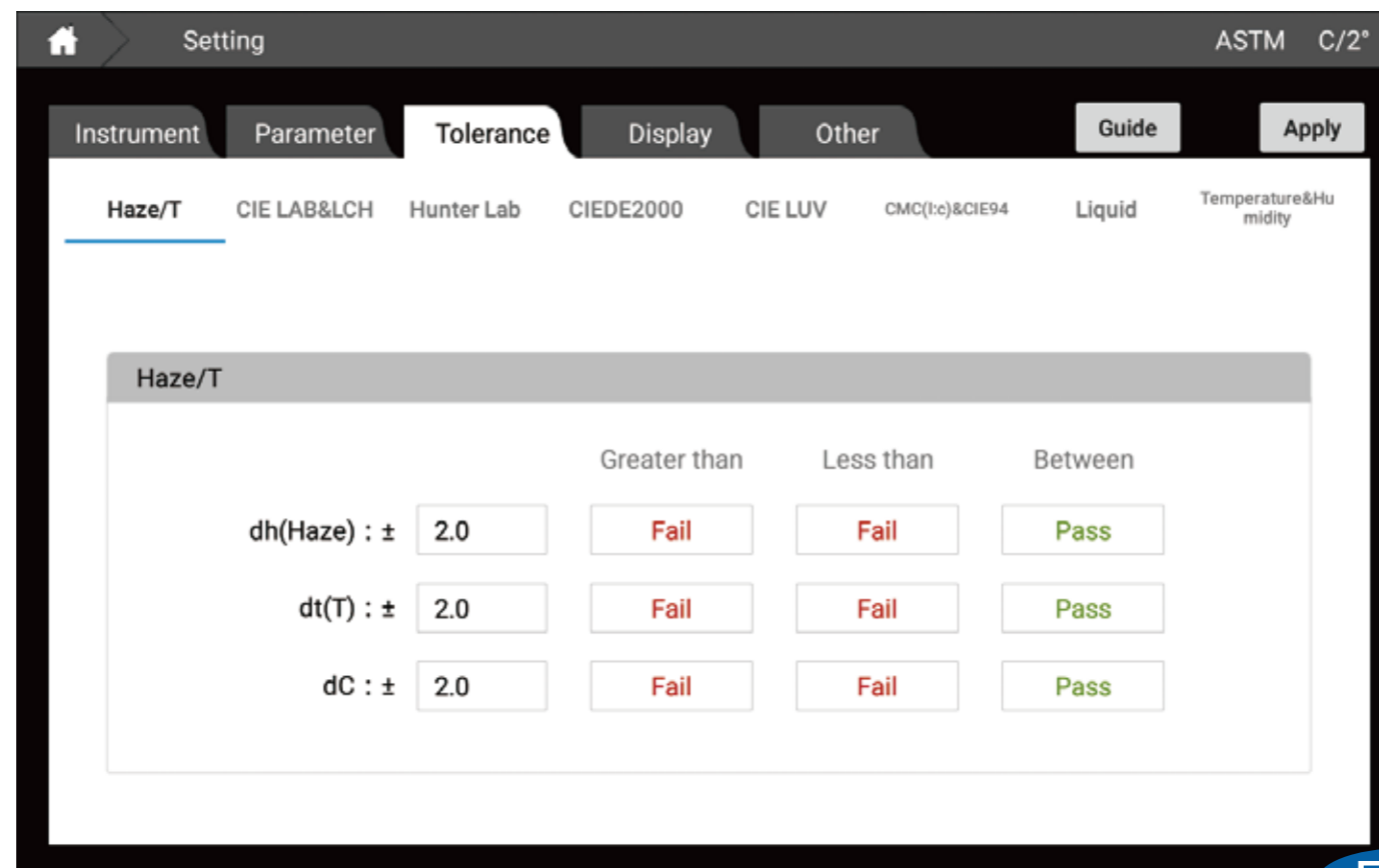

F-3

显示设置

显示设置可以设置“测量页面”下显示的内容。分为如下几个：

- 1、雾度/透过率/清晰度：同时显示雾度、总透过率以及清晰度参数；
- 2、雾度/透过率：同时显示雾度、总透过率参数
- 3、雾度：仅显示雾度参数；
- 4、透过率：仅显示总透过率参数；
- 5、清晰度：仅显示清晰度参数；
- 5、色差：CIELABCH、CIEDE2000、CIE94、CMC、HunterLab；
- 6、数据：该模式可以显示除了雾度与遮盖力以外该仪器所有能够测量的参数；
- 7、图像：CIE LAB图、Yxy图、Luv图、反射/透过率图、K/S曲线图、吸光度曲线图；
- 9、同色异谱：测量同色异谱参数；
- 10、液体色度：测量saybolt、ASTM color、铂钴色度、Gander color；

The screenshot shows a software interface for haze measurement. The main window has a top bar with a home icon, 'Setting', and 'ASTM C/2°'. Below this are tabs for 'Instrument', 'Parameter', 'Tolerance', 'Display', 'Other', 'Guide', and 'Apply'. A left sidebar lists measurement types: 'H/T/C', 'Haze/T' (highlighted), 'Haze', 'Transmittance', 'Clarity', 'Color Diff.', 'Data', 'Figure', 'Metamerism', and 'Liquid'. The main area displays a preview of the 'Haze/T' measurement screen. This preview includes a graph titled '透过率曲线(%)' with a y-axis from 0 to 200 and an x-axis labeled '波长 (nm)' from 400 to 700. A horizontal line is drawn at 100% transmittance. To the right of the graph is a table:

雾度	总透过率
0.00	100.00

On the right side of the preview window, there are icons for '设置' (Settings), '保存' (Save), and '测量' (Measure).

F-6

其他设置

- 1、平均设置窗口可以设置单次测量还是平均测量；
- 2、保存设置窗口可以设置手动保存还是自动保存；
- 3、命名规则窗口可以设置标样试样保存时候的名字规则。

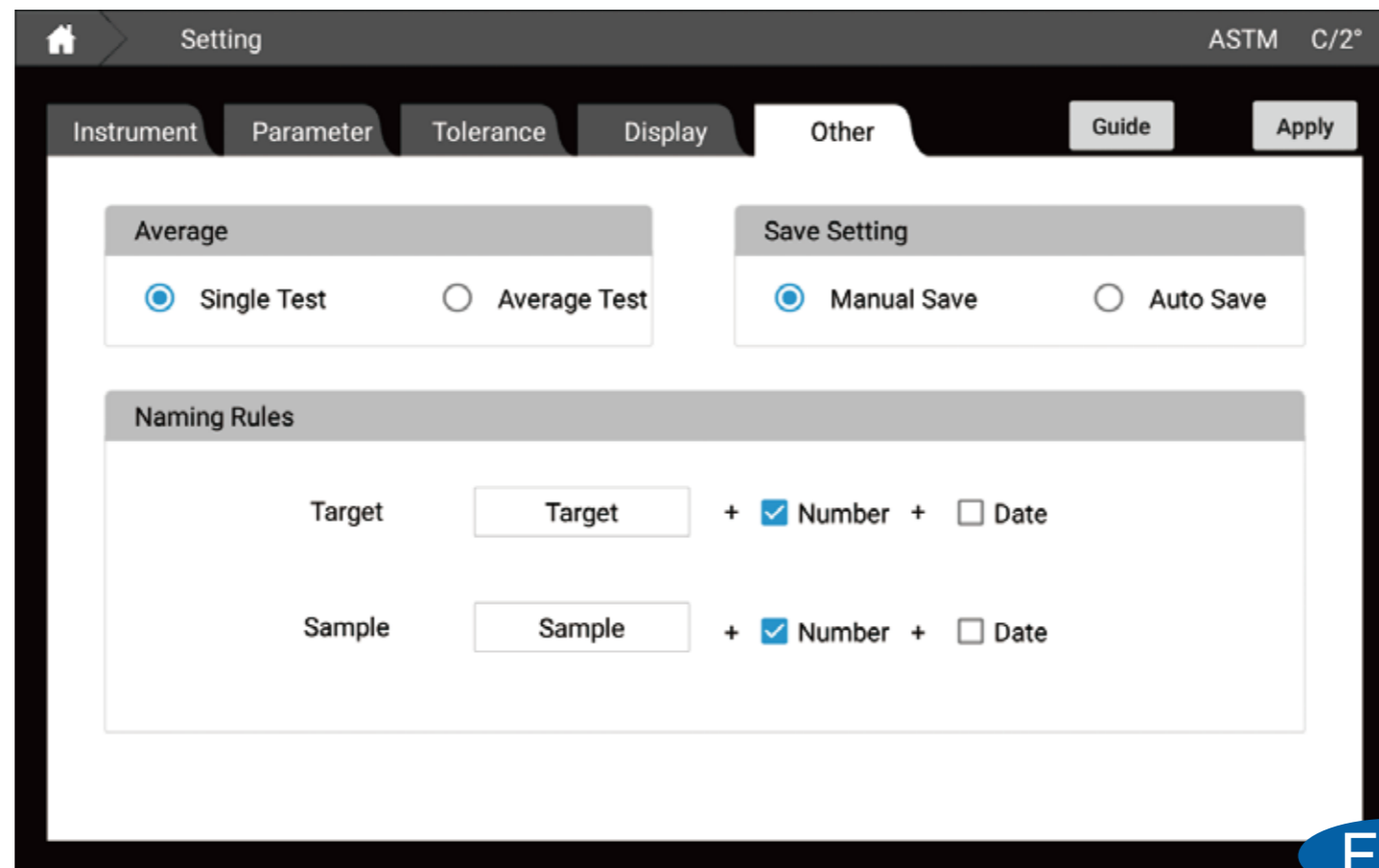

F-6

[数据浏览]

G

- 1、页面左边显示的是标样数据列表，右边是标样下的试样数据列表；
- 2、页面左边上面有一个搜索框，点击可以搜索标样数据；
- 3、点击其中一条标样后，可以在界面右边看到标样数据下的试样数据详细信息；
- 4、长按标样或试样可以选择调出、修改、删除当前选择、删除全部；
- 5、点击标样进入试样详细信息界面可以搜索当前标样下的试样，可进行导出当前显示数据；
- 6、点击参数编辑弹出参数编辑窗口，可以在这里面选择在数据界面显示的参数。

标样搜索框

标样数据列表

Home Data View ASTM C/2°

Target Search

Edit	Name	L*	a*	b*	dE*ab	P/F dB
Target	Target0001	99.99	-0.09	-0.06	--	--

Target0001

Test Search Name Search Export Export All

G-1

Home Data View ASTM C/2°

Target Search

Target0002

Target0001

Edit	Name	L*	a*	b*	dE*ab	P/F dB
Target	Target0002	99.99	-0.06	-0.08	--	--
0	Sample0001	100.01	-0.05	-0.13	0.05	Pas

Test Search Name Search Export Export All

G-2

试样数据列表

可进行导出当前显示数据和导出全部数据

Home Data View ASTM C/2°

Target Search

Target0002

Target0001

Edit	Name	L*	a*	b*	dE*ab	P/F dE
Target	Target0002	99.99	-0.06	-0.08	--	--
0	Sample0001	100.01	-0.05	-0.13	0.05	Pas

Set Into Target

Revise

Delete Selected

Delete All

Test Search Name Search Export Export All

G-3

ASTM C/2°

Data View

Preferences

Color space value	L*	Selected parameters	ADD DELETE REMOVE ALL	TOP UP DOWN BOTTOM
Color space	a*			
Color difference	b*			
Whiteness	c*			
Yellowness	h			
Blackness	X			
Transmittance	Y			
Color fastness	Z			
Force	x			
Color density				

FINISH

[个人中心]

H-1

个人中心界面可以修改账户密码，注销当前账号。

The screenshot displays the 'Individual Center' web interface. At the top, there is a navigation bar with a home icon, the text 'Individual Center', and the user's name 'ASTM' and 'C/2°'. Below the navigation bar, the interface is divided into two main sections. The left section, titled 'Account: admin', contains four input fields: 'Company Name', 'Address', 'Contact Name', and 'Email'. The right section, titled 'Change Password', contains three input fields: 'Old Password', 'New Password', and 'New Password Confirm', followed by an 'Enter' button. At the bottom right of the interface, there is a 'Logout' button.

H-1

[关于]

I-1

关于界面可以查看仪器的信息，比如软件版本，仪器版本，仪器序列号，仪器型号等等。

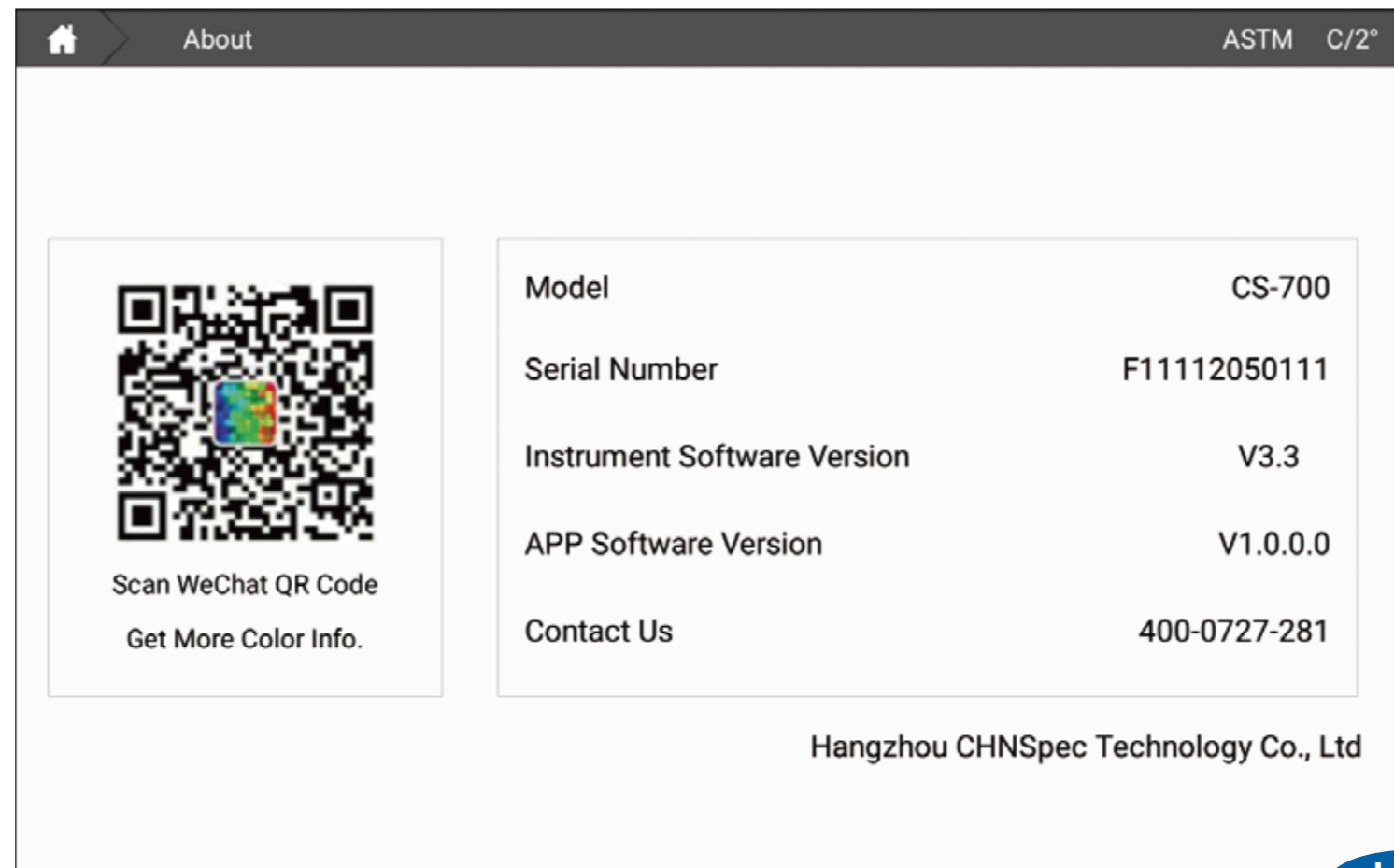

I-1

[日志]

J-1

日志界面可以看到仪器的登陆信息，校准信息，仪器错误信息等。

Time	Event
2016-01-02 20:43:05.3	100% successful calibration of instrument
2016-01-02 20:42:14.7	0% calibration succeed
2016-01-02 20:39:30.2	Account Login admin
2016-01-02 20:38:27.4	Account Login admin
2016-01-02 20:36:12.8	100% successful calibration of instrument
2016-01-02 20:35:56.4	0% calibration succeed
2016-01-02 07:34:28.4	100% successful calibration of instrument
2016-01-02 07:34:16.1	0% calibration succeed
2016-01-02 07:30:36.6	100% successful calibration of instrument
2016-01-02 07:30:23.9	0% calibration succeed

J-1

[更新]

K-1

联网情况下，可以点击更新检测是否有新软件，获取最新软件。

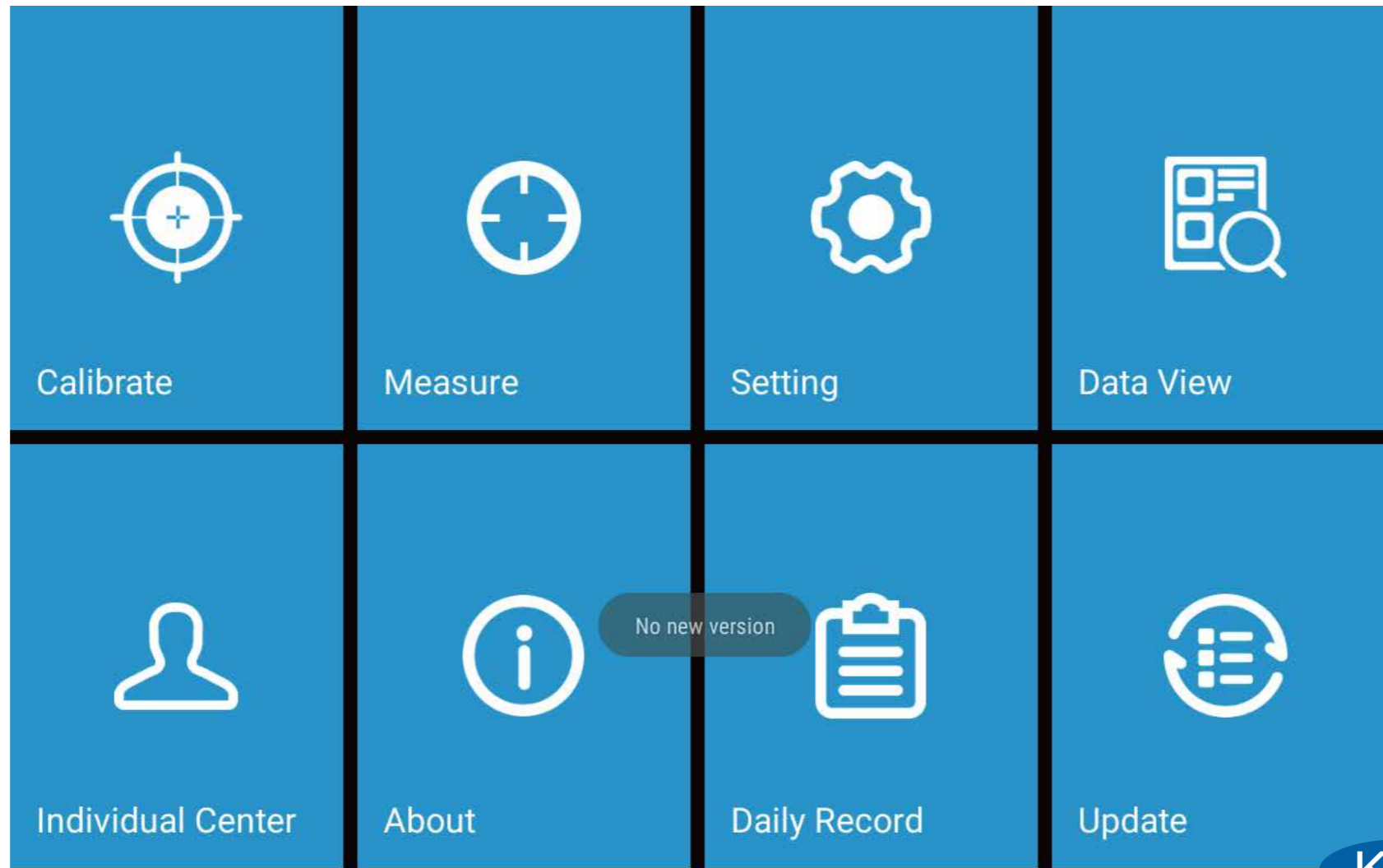

K-1

测量界面介绍

[雾度/透过率/清晰度]

L-1

在这个界面，可以同时显示雾度、总透过率、清晰度和透过率曲线（%），通过对比标样试样计算出雾度、总透过率和清晰度的差值，同时通过设定的容差自动判断样品是否合格。

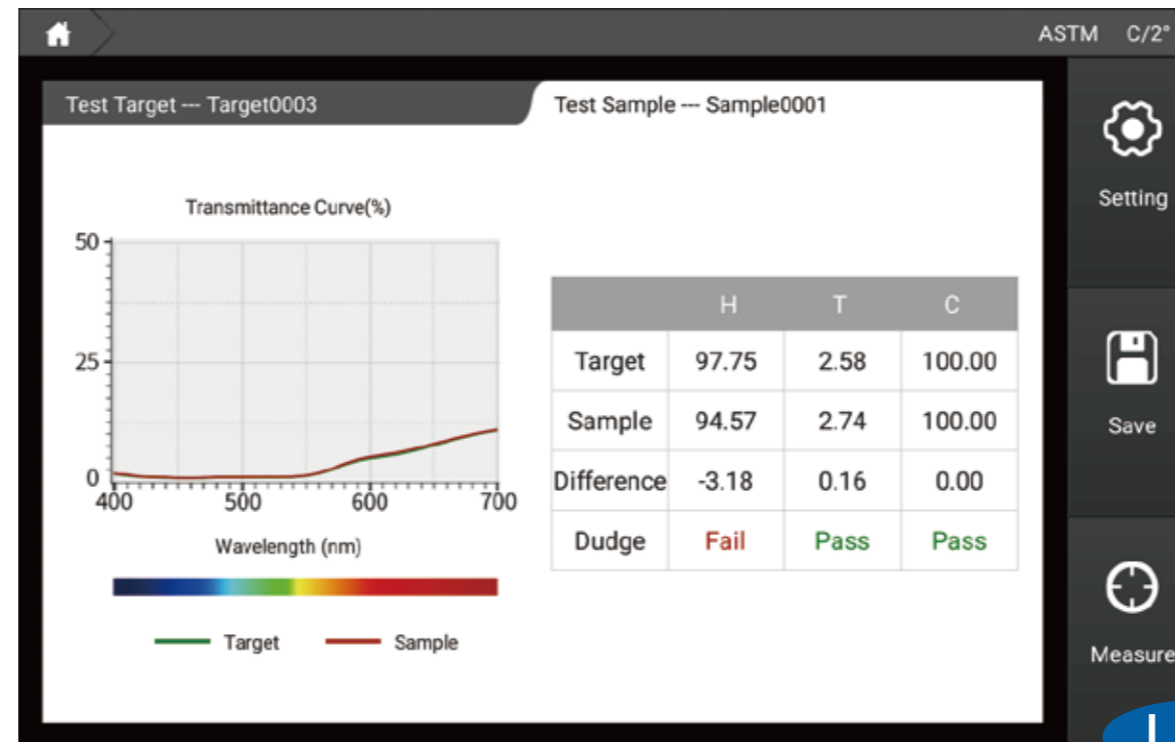

L-1

[雾度/透过率]

M-1

在这个界面，可以同时显示雾度、总透过率和透过率曲线（%），通过对比标样试样计算出雾度和总透过率的差值，同时通过设定的容差自动判断样品是否合格。

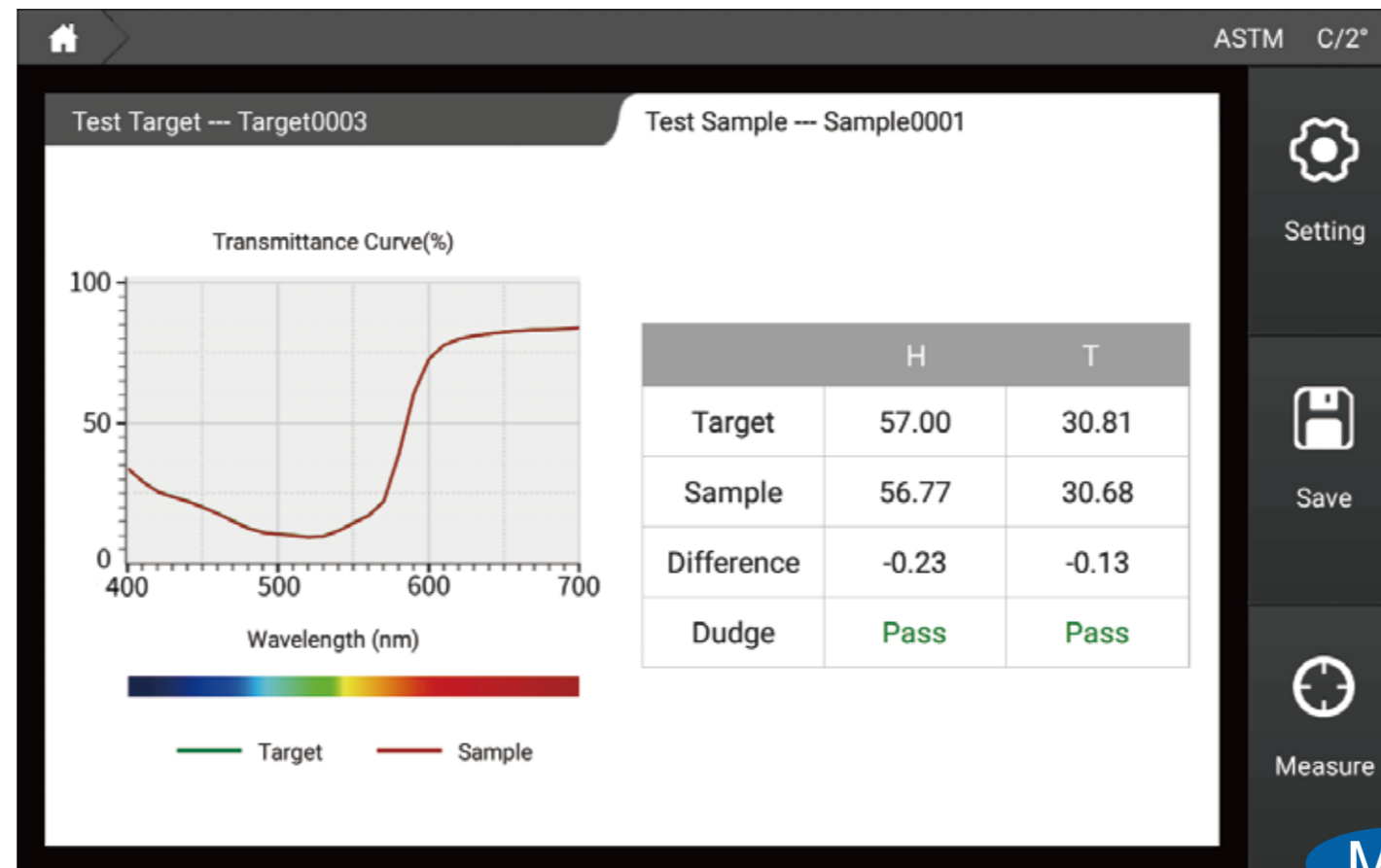

M-1

[雾度]

M-1

在这个界面，仅显示雾度和透过率曲线（%），通过对比标样试样计算出雾度的差值，同时通过设定的容差自动判断样品是否合格。

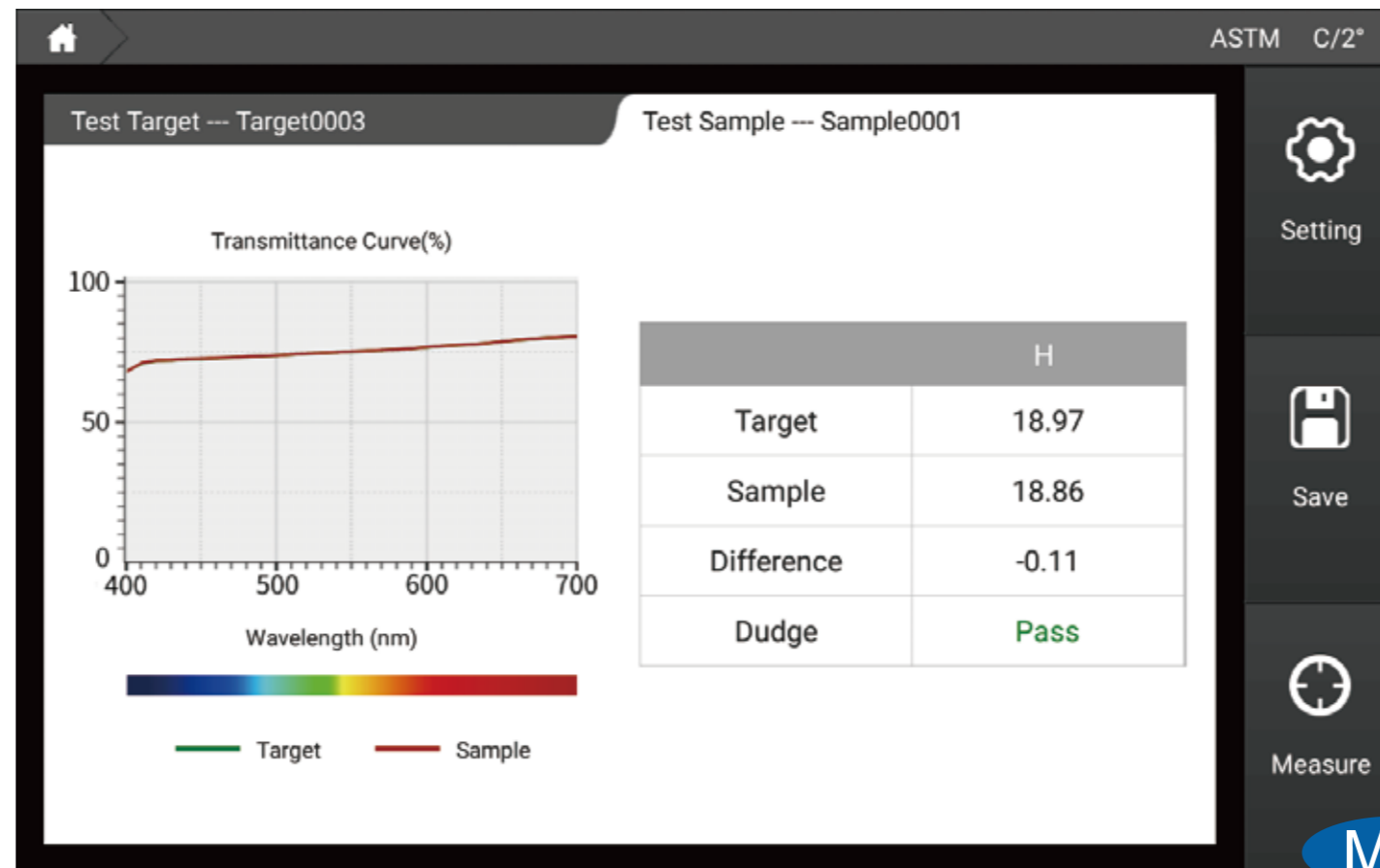

M-1

[透过率]

N-1

在这个界面，仅显示总透过率和透过率曲线（%），通过对比标样试样计算出总透过率的差值，同时通过设定的容差自动判断样品是否合格。

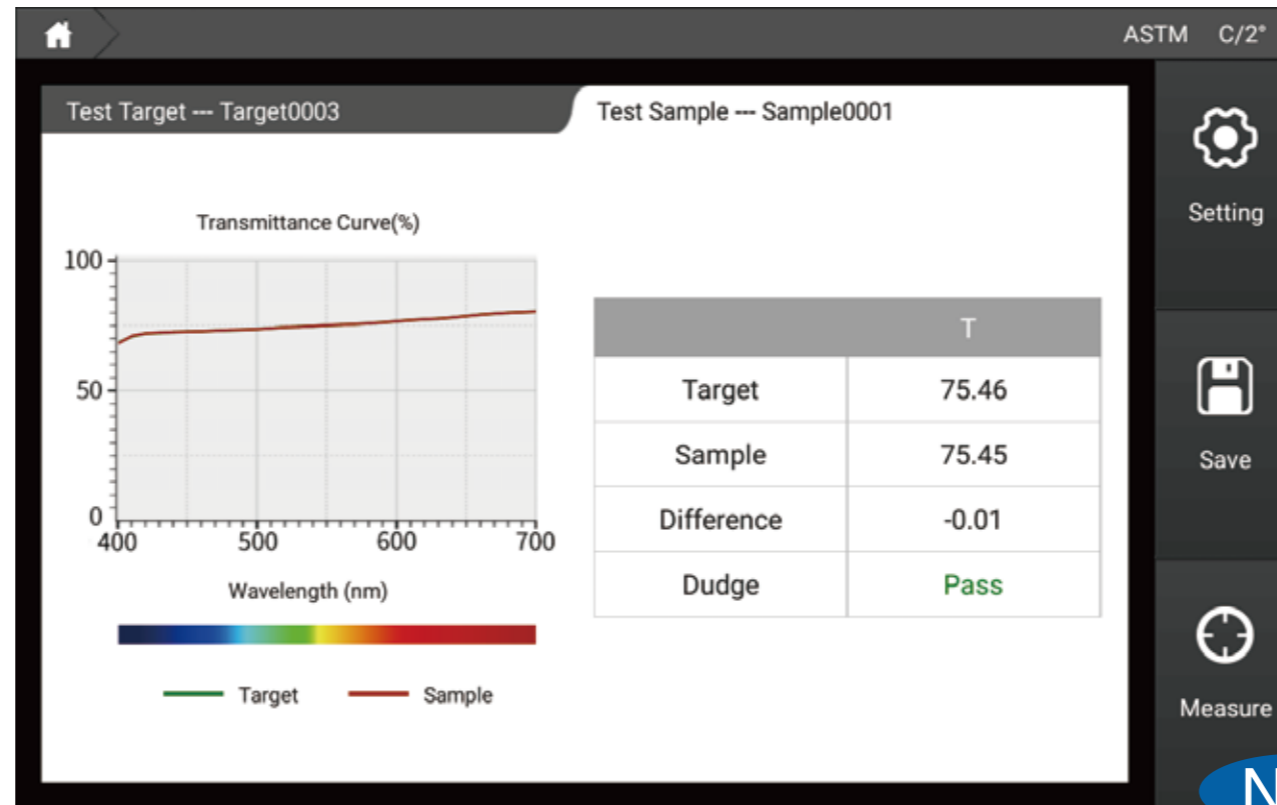

N-1

[清晰度]

0-1

在这个界面，仅显示清晰度，通过对比标样试样计算出清晰度的差值，同时通过设定的容差自动判断样品是否合格。

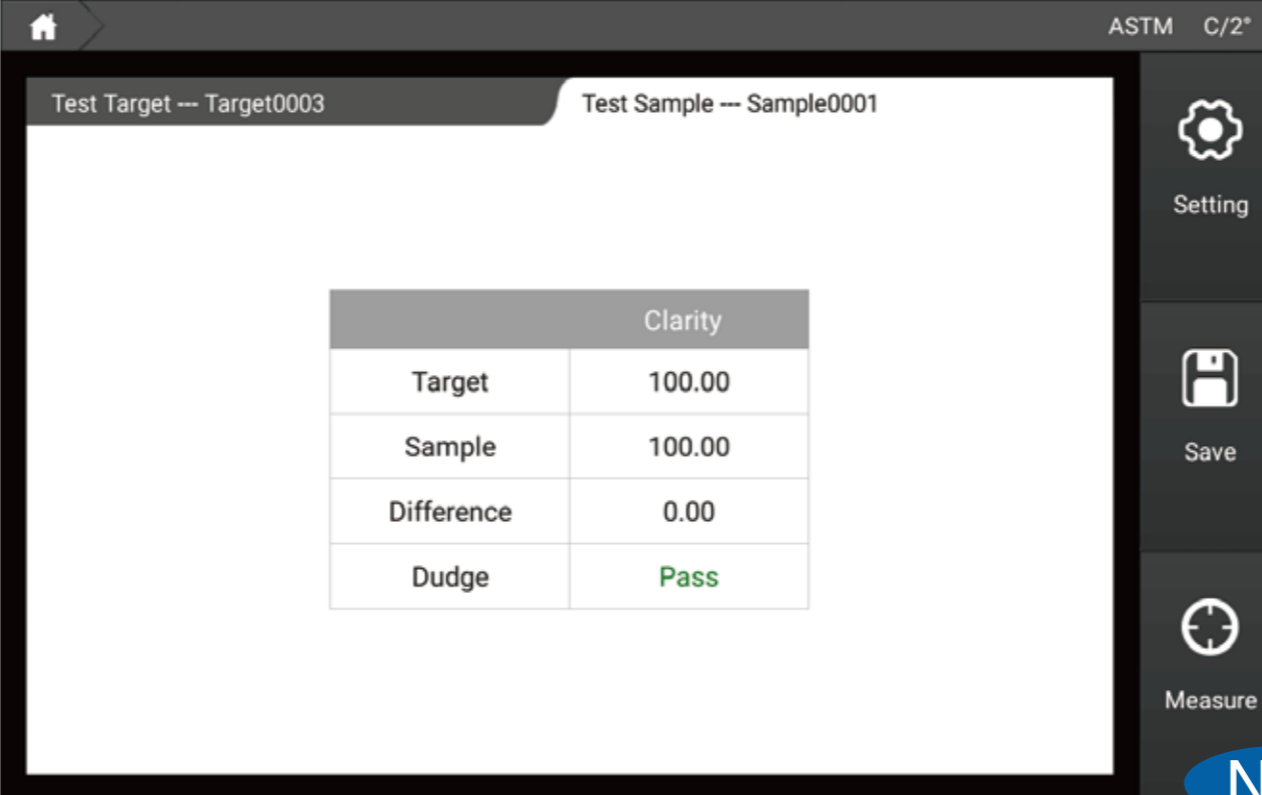

ASTM C/2°

Test Target --- Target0003 Test Sample --- Sample0001

	Clarity
Target	100.00
Sample	100.00
Difference	0.00
Dudge	Pass

Setting

Save

Measure

N-1

[色差]

P-1

CIELABCH

在这个界面可以测量样品颜色的 L^* 、 a^* 、 b^* 、 c^* 、 h 值，通过对比标样试样计算显示出 dL^* 、 da^* 、 db^* 、 dc^* 、 dH^* ，以及 dE^*_{ab} ，同时通过设定的容差自动判断样品是否合格。



Test Target --- Target0003

Test Sample --- Sample0001

Target

L* = 18.87
a* = 18.46
b* = 18.03
c* = 25.81
h = 44.34

Sample

L* = 19.03
a* = 18.56
b* = 17.25
c* = 25.34
h = 42.91

dL* = 0.15 Pass
da* = 0.10 Pass
db* = -0.78 Pass
dc* = -0.47 Pass
dH* = -0.64 Pass

dE*ab
0.81 Pass



Setting



Save



Measure

P-2

CIEDE2000

在这个界面可以测量样品颜色的L*、a*、b*、c*、h值，通过对比标样试样计算显示出dL'、dC'、dH'，以及dE*2000，同时通过设定的容差自动判断样品是否合格。

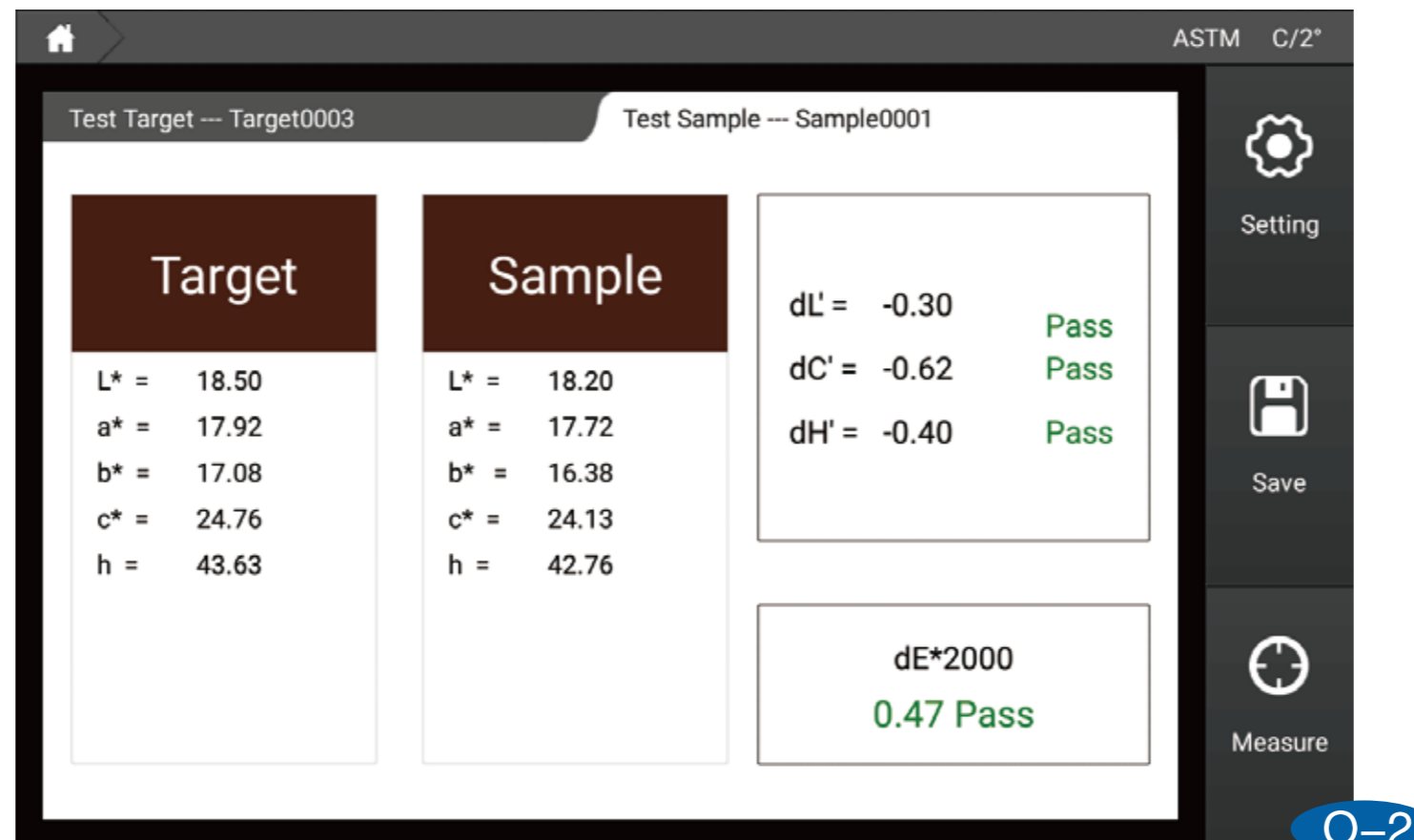

P-3

CIE94

在这个界面可以测量样品颜色的L*、a*、b*、c*、h值，通过对比标样试样计算显示出dL*、da*、db*、dc*、dH*，以及dE*94，同时通过设定的容差自动判断样品是否合格。

The screenshot shows a software interface for color measurement. At the top, it indicates 'ASTM C/2°'. Below this, there are two tabs: 'Test Target --- Target0003' and 'Test Sample --- Sample0001'. The interface is divided into three main sections:

- Target Data:**

L*	18.10
a*	17.98
b*	16.59
c*	24.47
h	42.70
- Sample Data:**

L*	17.79
a*	17.66
b*	15.99
c*	23.82
h	42.16
- Difference Values:**

dL*	-0.31	Pass
da*	-0.32	Pass
db*	-0.60	Pass
dc*	-0.64	Pass
dH*	-0.23	Pass

At the bottom, the total difference is shown as **dE*94: 0.46 Pass**. On the right side, there are three buttons: 'Setting' (gear icon), 'Save' (floppy disk icon), and 'Measure' (crosshair icon).

P-4

CMC

在这个界面可以测量样品颜色的L*、a*、b*、c*、h值，通过对比标样试样计算显示出dL*、da*、db*、dc*、dH*，以及dEcmc(l:c)，同时通过设定的容差自动判断样品是否合格。

ASTM C/2°

Test Target --- Target0003 Test Sample --- Sample0001

Target	Sample
L* = 18.33	L* = 18.32
a* = 18.35	a* = 18.51
b* = 16.26	b* = 16.65
c* = 24.52	c* = 24.90
h = 41.55	h = 41.97

dL* = -0.01	Pass
da* = 0.16	Pass
db* = 0.39	Pass
dc* = 0.38	Pass
dH* = 0.18	Pass

dEcmc(2.0:1.0)
0.30 Pass

Setting

Save

Measure

O-4

P-5

Hunter Lab

在这个界面可以测量样品颜色的Hunter L、Hunter a、Hunter b值，通过对比标样试样计算显示出dHunter L、dHunter a、dHunter b，以及dEab，同时通过设定的容差自动判断数据是否合格。

The screenshot displays the Hunter Lab software interface. At the top, it shows 'ASTM C/2°'. Below this, there are two tabs: 'Test Target --- Target0003' and 'Test Sample --- Sample0001'. The interface is divided into three main sections: 'Target (Hunter)', 'Sample (Hunter)', and a summary section for differences. The 'Target' section shows L = 15.99, a = 11.51, and b = 7.24. The 'Sample' section shows L = 15.92, a = 11.51, and b = 7.23. The summary section shows dL = -0.07 (Pass), da = -0.00 (Pass), db = -0.00 (Pass), and dEab = 0.07 (Pass). On the right side, there are three buttons: 'Setting' (gear icon), 'Save' (floppy disk icon), and 'Measure' (crosshair icon).

Parameter	Target (Hunter)	Sample (Hunter)	Difference	Status
L	15.99	15.92	dL = -0.07	Pass
a	11.51	11.51	da = -0.00	Pass
b	7.24	7.23	db = -0.00	Pass
dEab			0.07	Pass

O-5

[数据]

Q-1

- 1、在数据界面可以点击参数编辑来选择你想要看的参数；
- 2、通过测量标样，然后测量试样来查看样品的参数差值；
- 3、点击数据可以选中，长按数据可以对数据进行删除，重命名等操作。

Edit	Name	L*	a*	b*	dE*ab	P/F dE*s
Target	Target0003	19.20	18.68	17.05	--	--
1	Sample0001	18.88	18.68	17.27	0.39	Pass

P-1

[图形]

R-1

CIELAB

在该界面可以测量样品的L*、a*、b*值，同时用该样品的a*、b*值在CIELAB图上描点并显示数据的L*、a*、b*值。

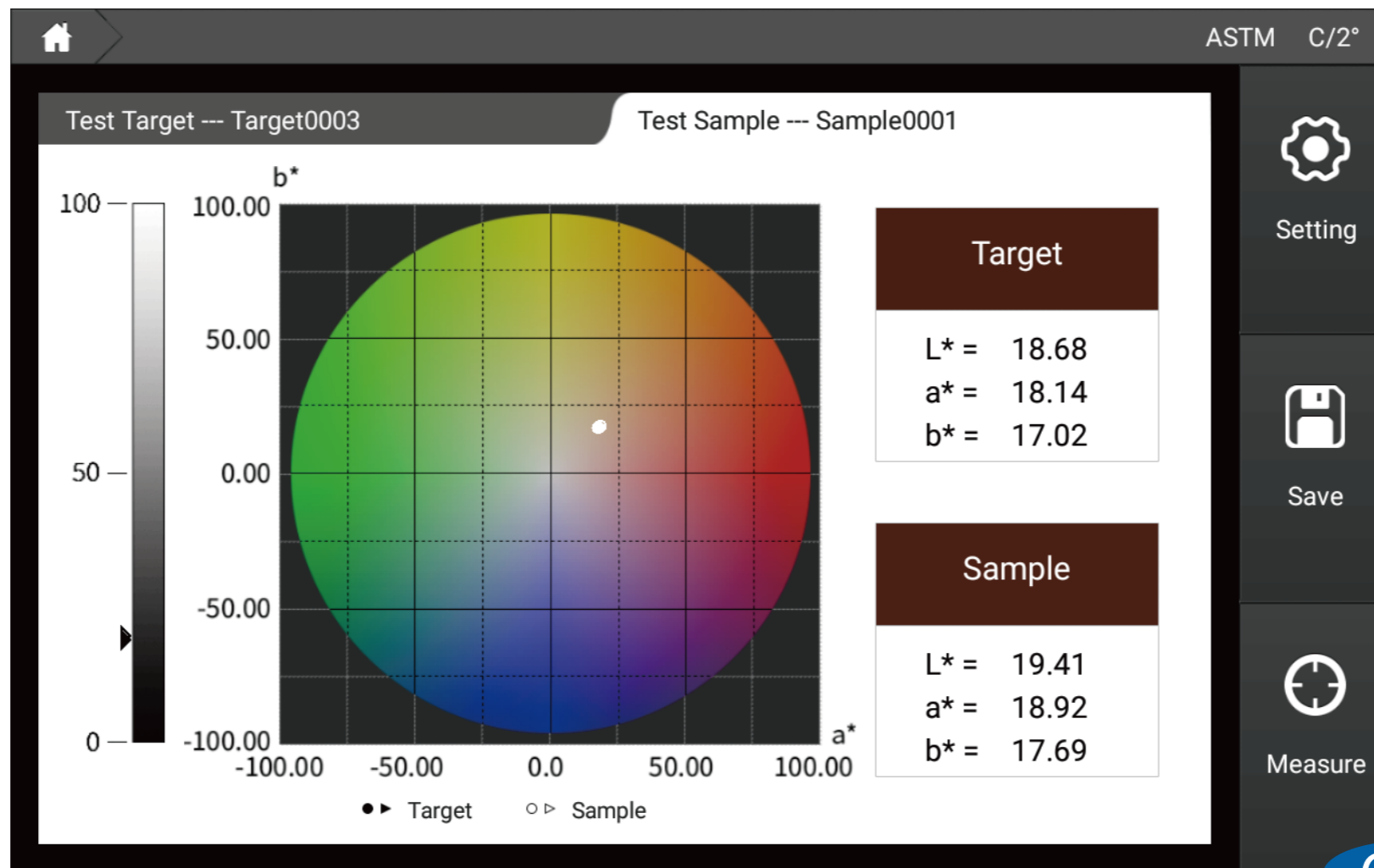

Q-1

R-2

Yxy

在该界面可以测量样品的Y、x、y值，同时用该样品的x、y值在Yxy图上描点并显示数据的Y、x、y值。

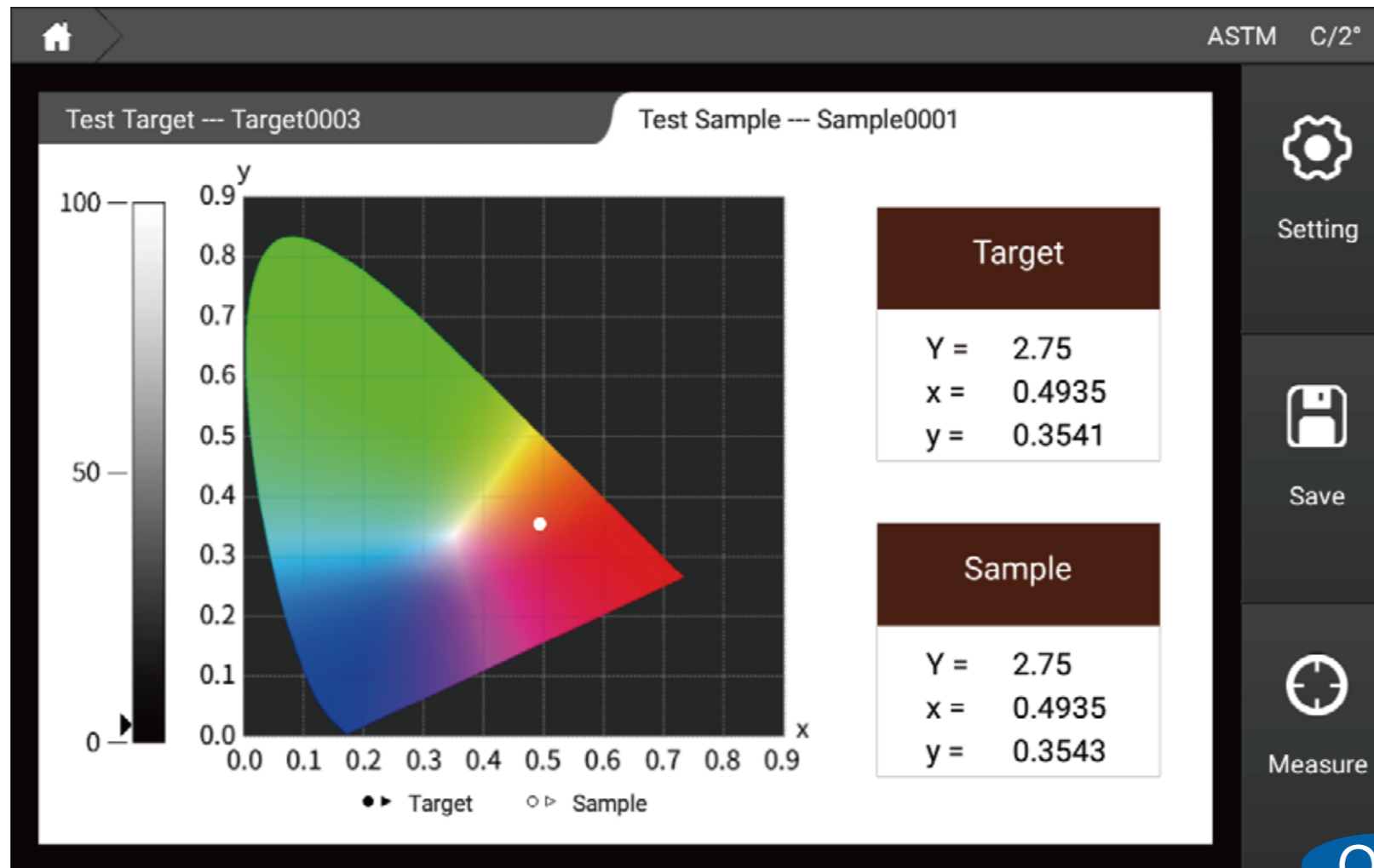

R-3

Luv

在该界面可以测量样品的 L^* 、 u^* 、 v^* 值，同时用该样品的 u' 、 v' 值在Luv图上描点并显示数据的 L^* 、 u^* 、 v^* 值。

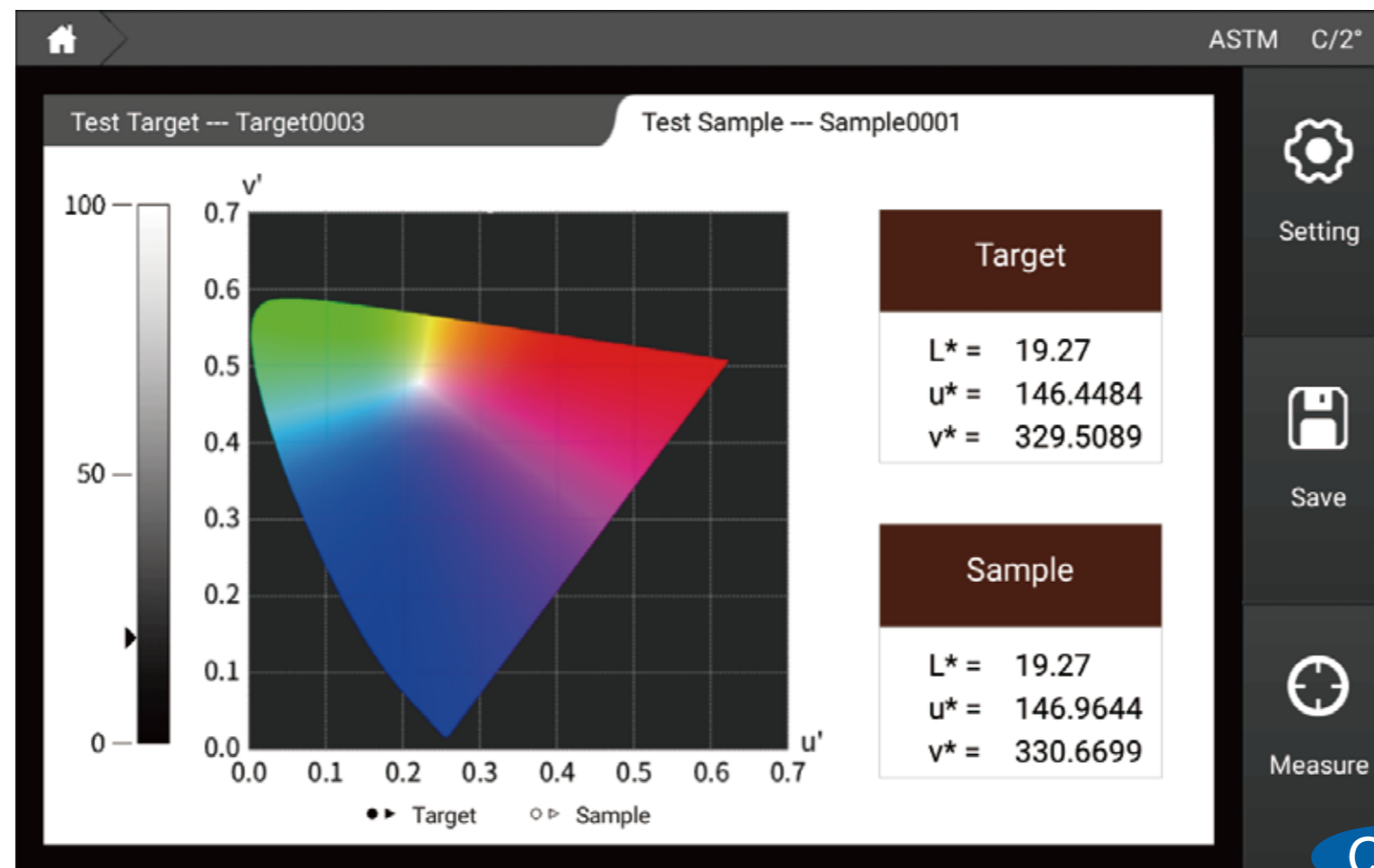

Q-3

R-4

k/s曲线

在该界面可以测量样品的k/s值，同时显示360–780nm下的K/S曲线图。

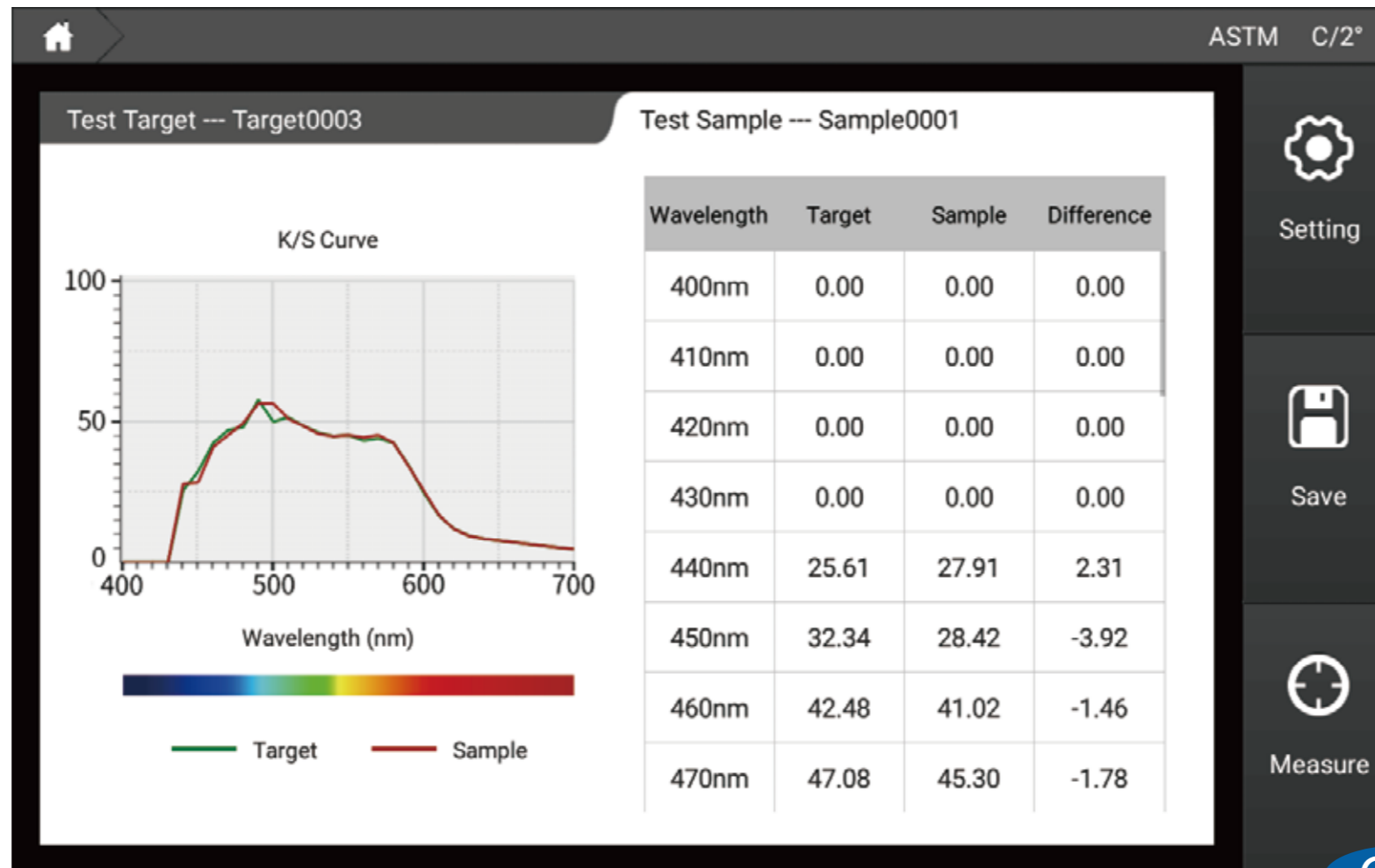

Q-4

R-5

透过率曲线

在该界面可以测量样品的透过率值，同时可以显示360-780nm下的透过率曲线图。

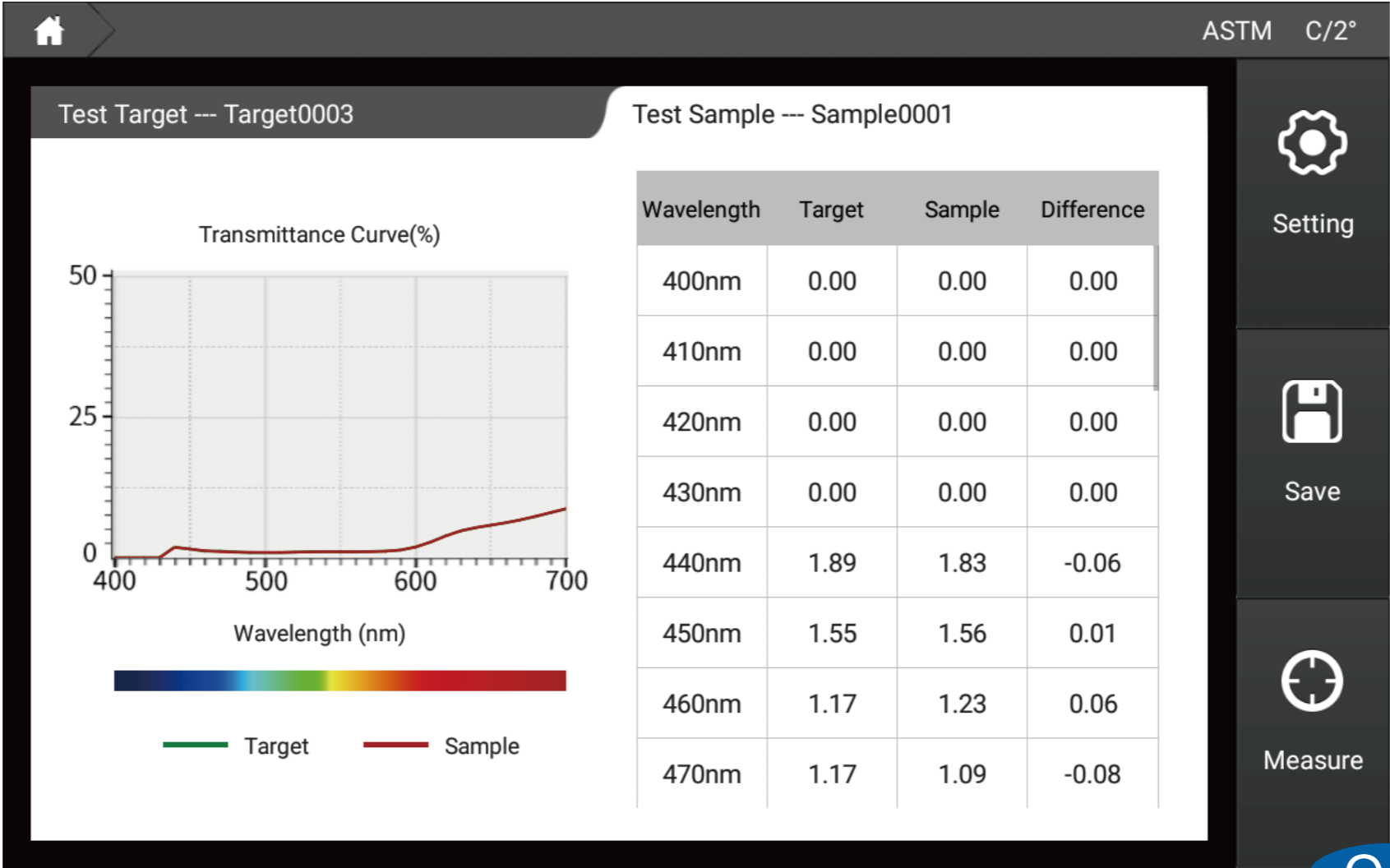

Q-5

R-6

吸光度曲线

在该界面可以测量样品的吸光度值，同时可以显示360-780nm下的吸光度曲线图。

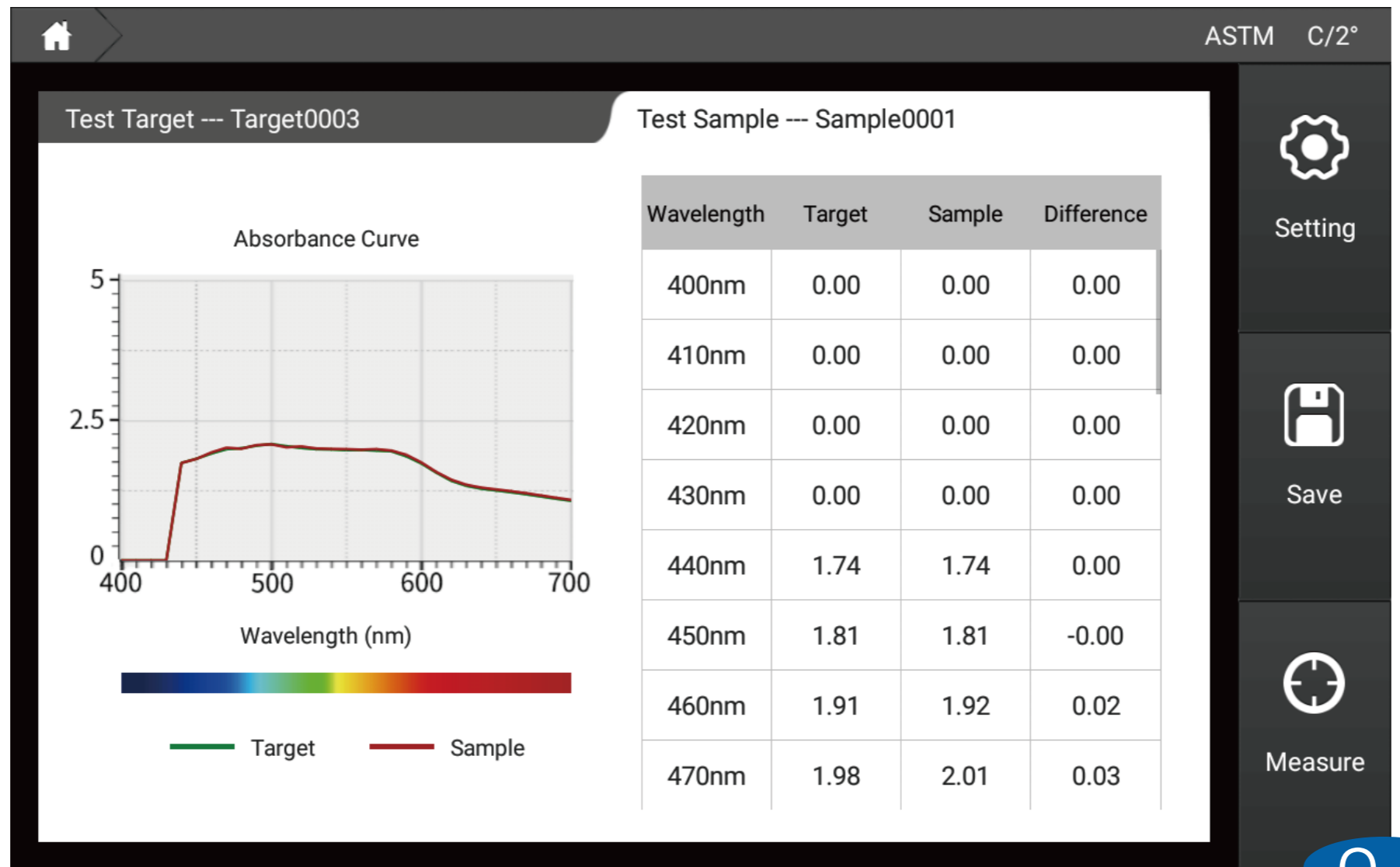

Q-6

[同色异谱]

S-1

界面左边是测量样品使用第一光源/角度计算出来的数值，右边是测量样品使用第二光源/角度计算出来的数值，界面中见下面的同色异谱值是样品在两光源角度下计算出来的同色异谱数值。

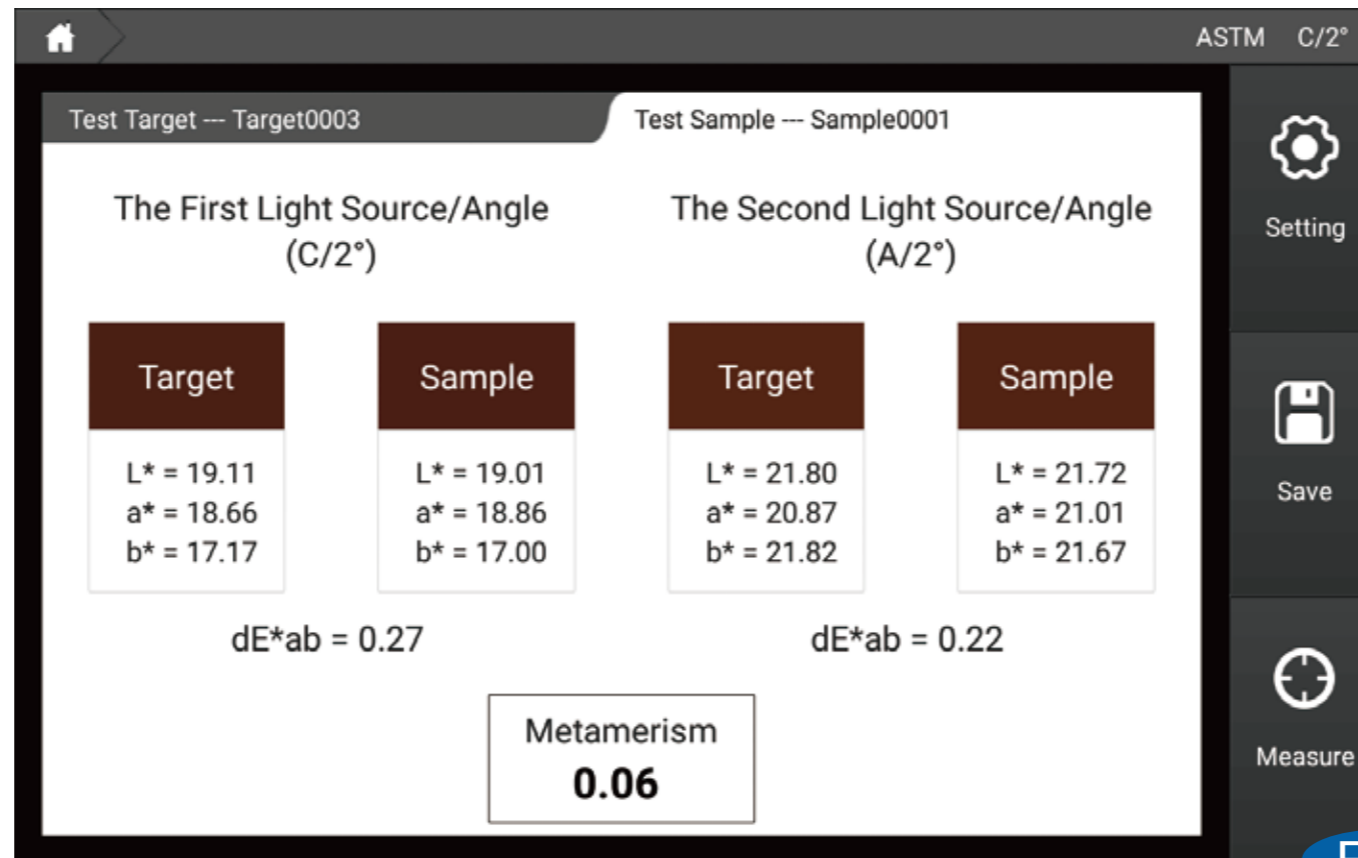

R-1

[液体色度]

T-1

界面左边比色皿光程是测量不同参数推荐的比色皿光程大小(例如您想测量saybolt参数，这个时候推荐的比色皿光程大小是50mm)，右边是参数的数值，以及是否合格判断。

。

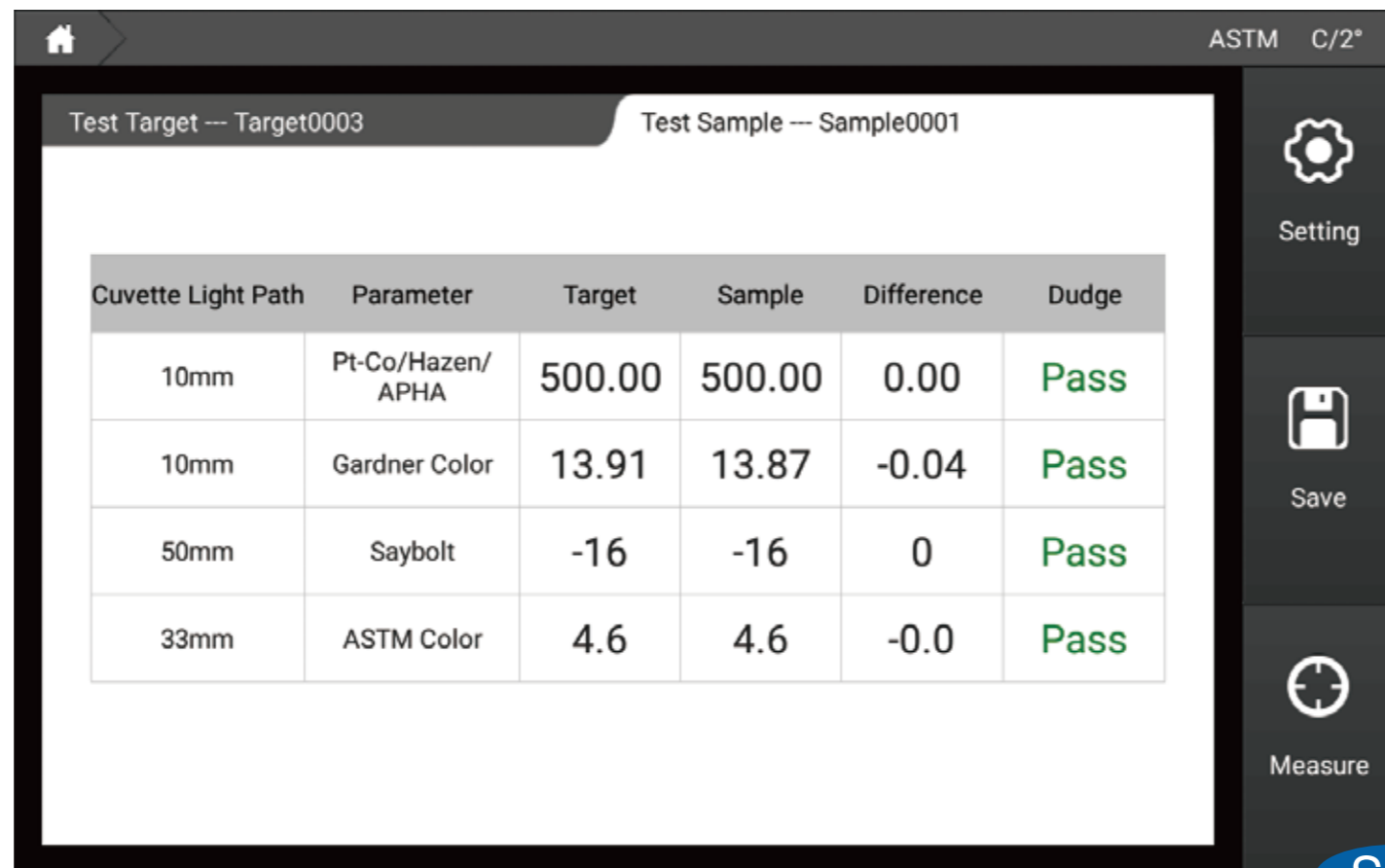

Cuvette Light Path	Parameter	Target	Sample	Difference	Dudge
10mm	Pt-Co/Hazen/APHA	500.00	500.00	0.00	Pass
10mm	Gardner Color	13.91	13.87	-0.04	Pass
50mm	Saybolt	-16	-16	0	Pass
33mm	ASTM Color	4.6	4.6	-0.0	Pass

S-1

参数介绍

雾度

漫散射会降低物体的成像质量。材料内部细小的颗粒或样品表面会引起散射，散射光会散射到不同的角度且每个角度的光密度都很小，这会导致对比度的降低，样品会形成如牛奶或云雾状的外观，这一现象称为雾度。

透明度评估条件

透明产品外观具有光泽、颜色和透明度等特性。透明度尤为重要，其评估条件为：透光率，雾度等。透过率是全部透射的光与入射光的比率。它会随材料表面对光的反射和吸收而降低。根据ASTM D1003标准，雾度是超出 2.5° 散射的入射光所在全部入射光的百分比。

测量原理

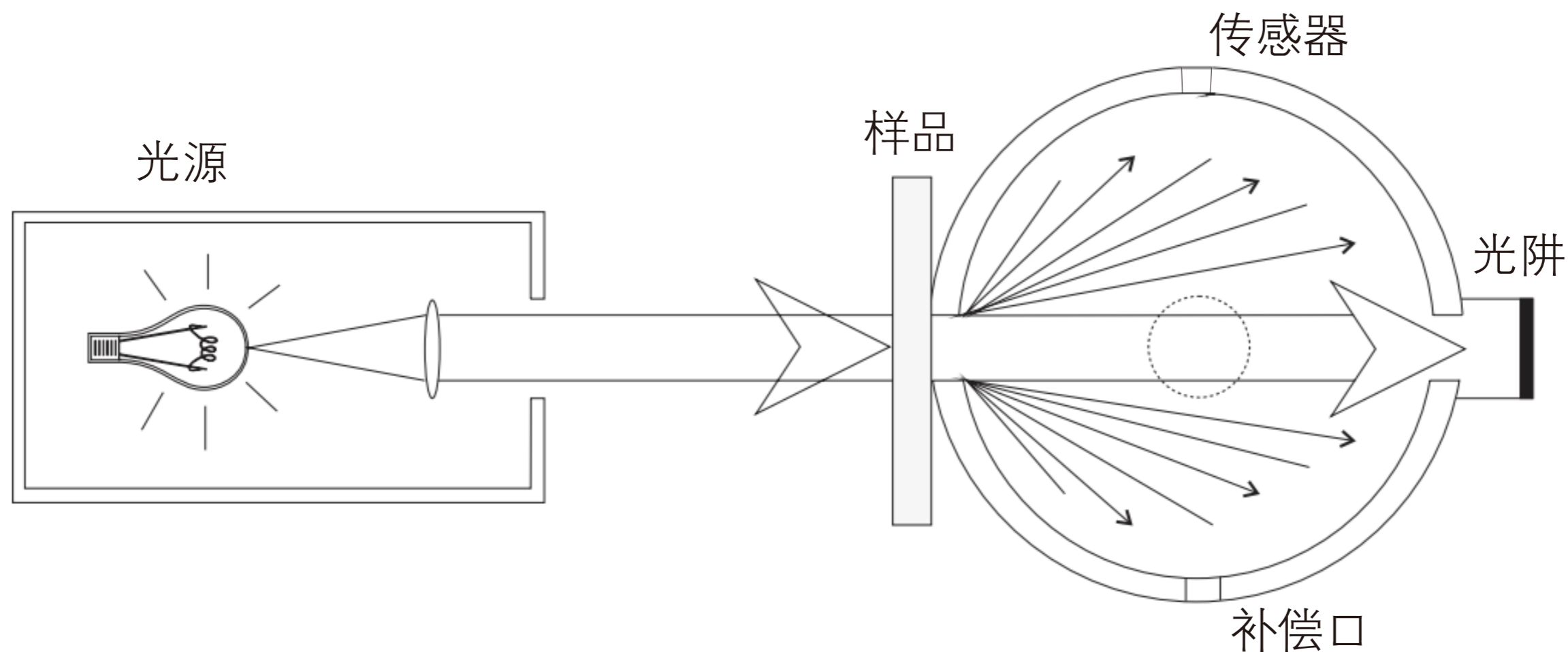

一束平行光照射到样品后进入一个积分球体内。光线在球体内壁白色涂层上进行散射，通过感应器进行测量，球体右侧光阱出口关闭时测量全透过率。右侧光阱出口开启时测量雾度。

补偿法

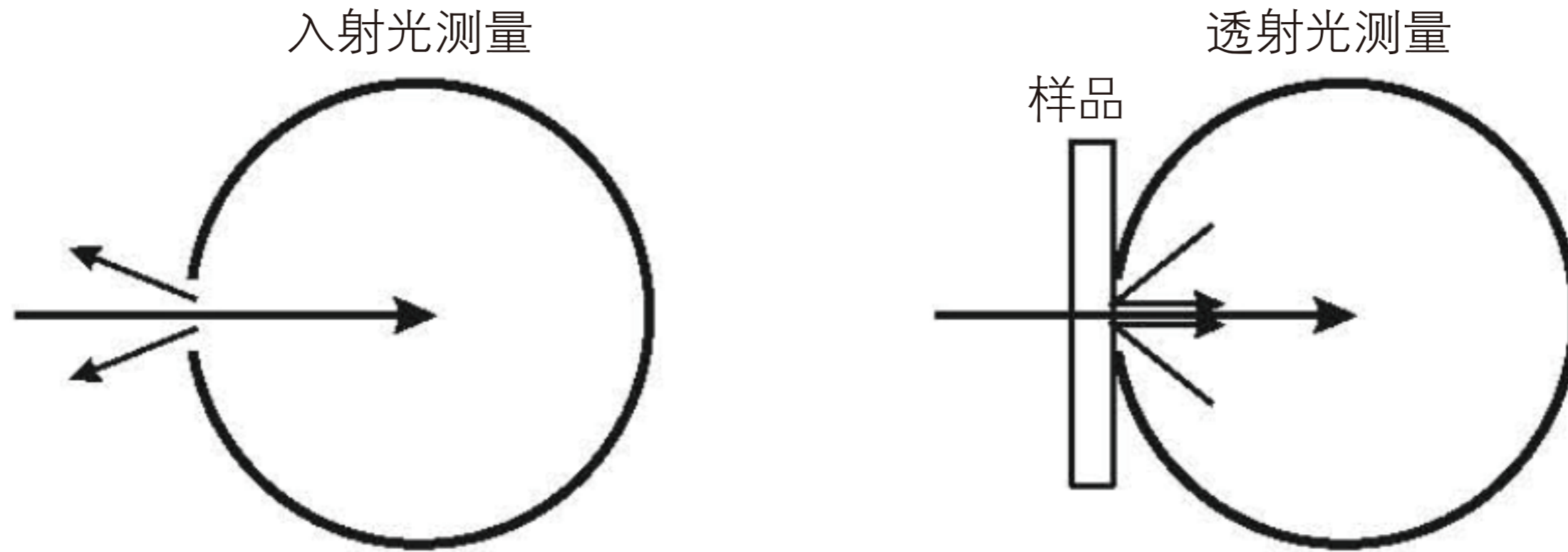

上图为不采用补偿法测量透过率，在两次测量中，由于积分球的面积不相同，导致积分球效率不同，从而对测量结果的准确性产生一定影响。

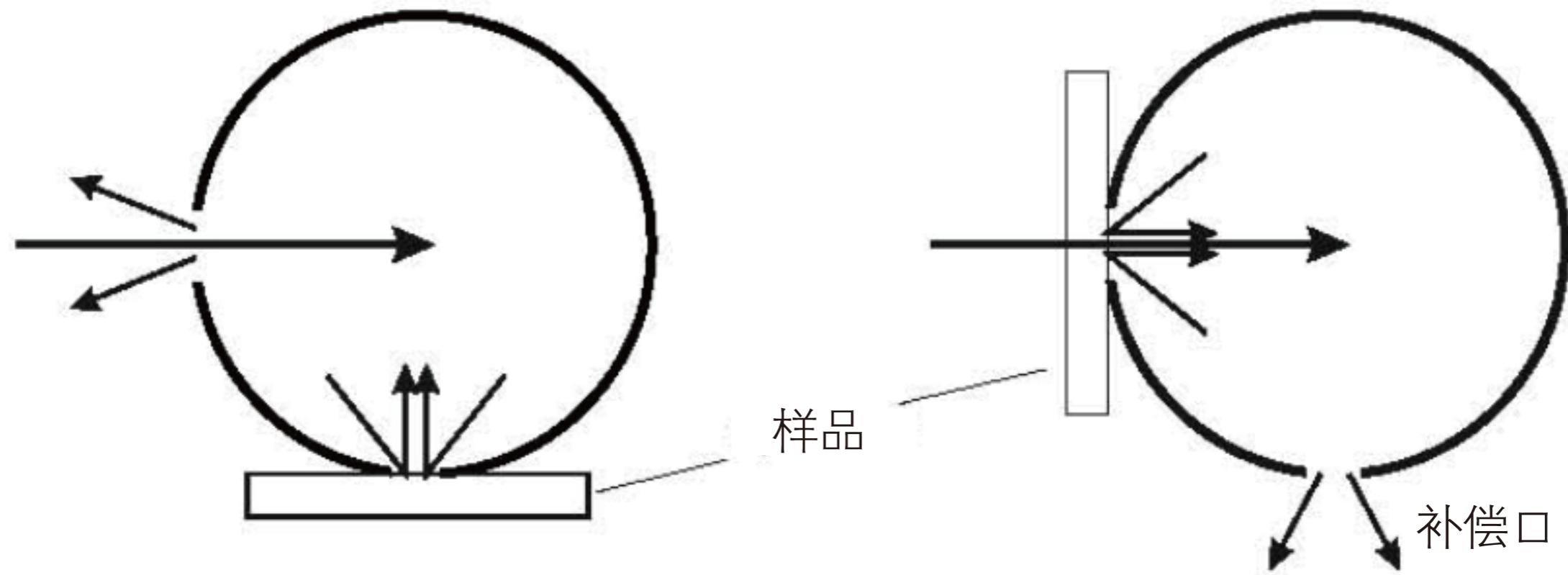

上图为采用补偿法测量透过率，在积分球上增加一个补偿口，第一次测量样品放置于补偿口处，第二次测量样品放置于测量口，同时补偿口处于打开状态，两次测量过程积分球面积完全一致，保证积分球效率一直，从而使测量结果更准确。

异常处理分析

异常情况	分析	处理方法
1、仪器无法开机	电源连接可能异常	检查电源接口处是否接触良好，并插好电源
2、开机后不能进入主程序	开机校准过程可能异常	重新按照要求进行校准保证校准顺利通过
3、测量结果报错	容差设置可能异常	检查容差设置并调整
4、测试数值异常	1、样品与测量口贴合紧密与否 2、样品表面损伤是否较大	1、检查样品与测量口的贴合情况，保证紧密贴合 2、检查样品表面情况，保证样品是完好的对测量没有影响的

附件

标配件

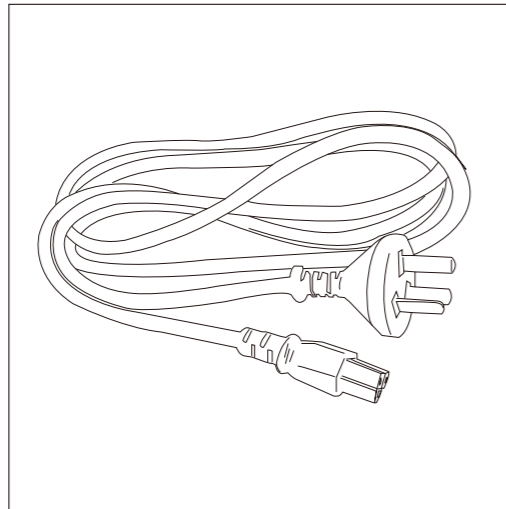

外部电源适配器

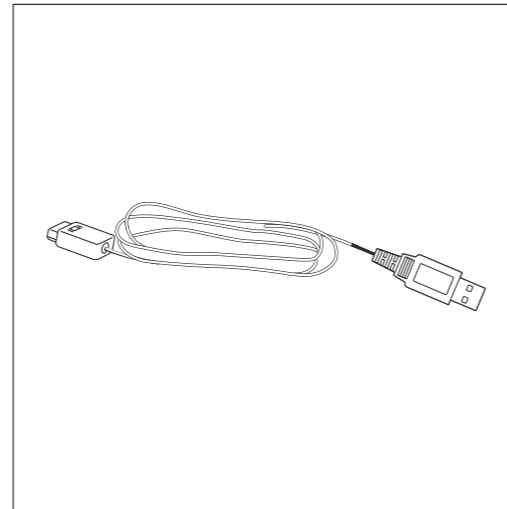

USB数据线

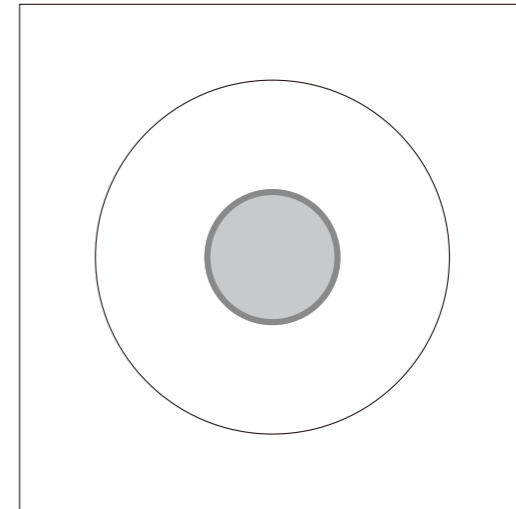

数据管理软件光盘

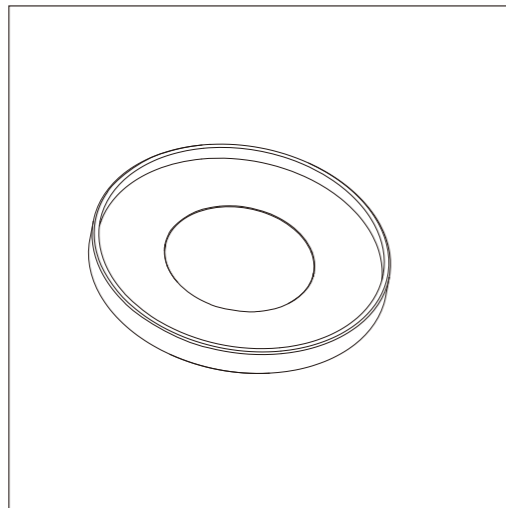

补偿口盖子

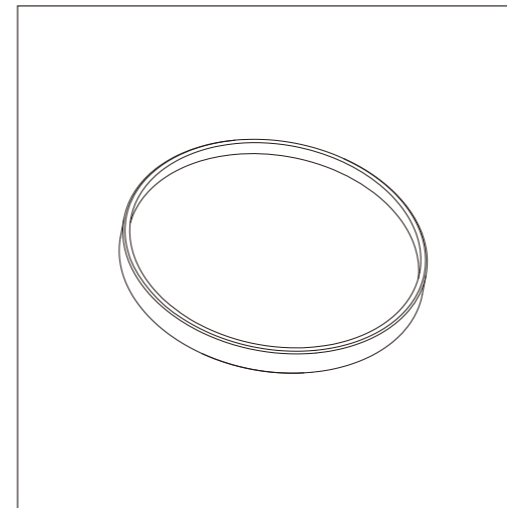

0校准遮光盖

选配件

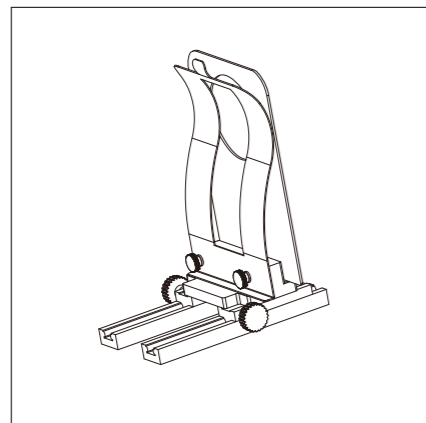

固体样品夹具

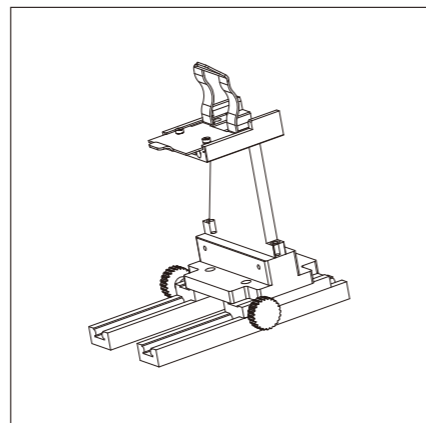

比色皿夹具

公司声明

- 本公司向用户承诺，本产品保修期限为购买之日起的三年时间内有效，正常使用情况下非人为造成的故障问题，本公司将负责给予免费维修，超过保修期或人为因素导致的故障，本公司将提供维护，将收取维修材料及相关费用。
- 本公司对于第三者因使用本产品引起的任何损失或索赔不负任何责任。
- 本公司对由于故障、维修、断电或更新软件造成的数据丢失而导致的任何损害或损失均不负任何责任。为防止重要数据的丢失，请务必对所有重要数据进行备份。
- 本产品中预置的所有作品之版权归本公司所有，受《中华人民共和国著作权法》保护。
- 我公司出售本产品的行为不代表向用户转让或授予与作品版权相关的任何权利。
- 本说明书所提到的产品规格及信息仅供参考，内容会随时更新，恕不另行通知。

Operate Manual

CATALOGUE

[I] Usage Notice	01
[II] Precautions	02
[III] Functional description	03
[IV] Technical Paramet	04
[V] Introduction to appearance structure	05
[VI] Measurement flow chart	06
[VII] Software interface introductio	08
7.1 Features	08
7.2 Login	10
7.3 Guide	13
7.4 Calibration	19
7.5 Measure	22
7.6 Set up	25
7.7 Data browsing	32

7.8 Personal center	37
7.9 About	38
7.10 Log	39
7.11 Update	40
[VIII] Introduction to the measurement interface	41
8.1 Haze/transmittance/Clarity	42
8.2 Haze/transmittance	42
8.3 Haze	43
8.4 Transmittance	44
8.5 Clarity	45
8.6 Color difference	46
8.7 Data	52
8.8 Figure	53
8.9 Metamerism	59
8.10 Liquid	60
[IX] Parameter introduction	61
[X] Exception handling analysis	65
[XI] Annex	66
[XII] Company statement	68

Usage Notice

- 1、 This machine is an instrument designed to measure the haze, total light transmittance, and spectral transmittance of transparent, translucent parallel plane materials such as plastics, films, glass products, LCD panels, etc.
- 2、 This machine is widely used in laboratory, factory, or field operation, enough to achieve the best haze and color measurement in quality control in almost all application fields.
- 3、 The time period of the limited warranty is the time since the purchase of this instrument (time: such as one year). If your instrument needs service, please bring the instrument to the local sales department to contact us for repair.
In order to avoid affecting the accuracy of the instrument, please do not
- 4、 disassemble the instrument without permission. If the instrument is damaged due to unauthorized disassembly of the machine or incorrect use, the user is responsible for it.

Precautions

- 1、 Carefully put the instrument on a flat surface.
- 2、 This instrument is not moistureproof, please store the instrument in a dry area.
- 3、 Large force, or sharp objects may damage the screen.
- 4、 It is recommended to use the original power adapter which comes with the instrument.
- 5、 To ensure the machine to work properly, please do not store, or use the instrument in places that are too hot or too cold; please do not put the machine in damp locations, or directly under sunlight. Do not use the instrument in severe environment such as strong shock or quake.
- 6、 Please avoid strong electromagnetic interference in usage.
- 7、 To ensure accurate measurement, please keep the instrument stable during the test and do not shake it.
- 8、 Instrument belongs to high precision instrument, please keep it well after usage.
- 9、 Do not clean the inside of the integrating sphere.
- 11、 If the instrument fails, please don't try to repair it by yourself, our customer service department will quickly help the customer.

12、 Any future update on the manual, we are not obliged to notify you.
If any questions, please contact us directly.

Functional description

- 1、 Color and Haze meter conforms to standards: GB/T 2410, ASTM D 1003, ISO 13468, ISO 14782 and GB/T 2410-2008, JJF 1303-2011.
- 2、 Color and Haze meter can provide haze and transmittance value under CIE-A, CIE-C and CIE-D65 light sources.
- 3、 Color and Haze meter contains compensation method which provides higher accuracy on test result.
- 4、 Open sample measurement area to make it can measure samples at any sizes.
- 5、 Haze meter adopts 7.0 inch capacitive touch screen and Android operating system for friendly interface.
- 6、 Haze, color and transmittance analysis software to meet customer's requirement on data analysis and management.

Technical Parameters

Light Source	Haze/ Transmittance: CIE-A,CIE-C,CIE-D65 Chromaticity Value: A,C,D50,D55,D65,D75,F1,F2,F3,F4,F5,F6,F7,F8,F9,F10,F11,F12,CMF, U30,DLF,NBF,TL83,TL84
Standard	ASTM D1003/D1044,ISO13468/ISO14782,JIS K 7105,JIS K 7361,JIS K 7136,GB/T 2410-08,CIE No.15,ISO 7724/1,ASTM E1164,DIN 5033 Teil7,JIS Z8722 Condition c标准
Measurement Parameter	HAZE,Transmittance (T),Clarity(C),CIE Lab,LCh,CIE Luv,XYZ,Yxy,Spectral Transmittance, Hunter Lab MunsellMI,CMYK,WI(ASTM E313-00,ASTM E313-73,CIE/ISO,Hunter, Taube Berger Stensby),YI(ASTM D1925,ASTM E313-00,ASTM E313-73), Tint(ASTM E313-00),Metamerism IndexMilm,APHA,Pt-Co,Gardner, Color difference (ΔE^*ab , ΔE^*CH , ΔE^*uv , $\Delta E^*cmc(2:1)$, $\Delta E^*cmc(1:1)$, ΔE^*94 , ΔE^*00)
Spectral Response	CIE Luminosity function Y/V(λ)
Wavelength	400-700nm
Wavelength Interval	10nm
Geometry	0/d
Measurement Area/Sample Port	18mm/25.4mm
Measurement Range	0-100%
Haze Resolution	0.01%
Haze Repeatability	Haze < 10%, repeatability $\leq 0.05\%$; Haze $\geq 10\%$, repeatability $\leq 0.1\%$; Transmittance $\leq 0.1\%$
Sample Size	Thickness $\leq 145\text{mm}$
Display	7 inch capacitive touch screen
Memory	20000values
Storage	Mass storage
Interface	USB-A,USB-B
Power	220V (with power cable)
Working Temperature	5 $^{\circ}$ - 40 $^{\circ}$ C , Relative humidity 80% or lower (35 $^{\circ}$ C) no condensation
Storage Temperature	-20 $^{\circ}$ C - 45 $^{\circ}$ C , Relative humidity 80% or lower (35 $^{\circ}$ C) no condensation
Size	LxWxH: 598mmX247mmX366mm
Weight	12kg
Standard Accessory	PC software (Haze QC)
Optional	Measurement Fixture、Haze Standard Plate、5mm/7mm/10mmCaliber plate、40*10Cuvette

Appearance and structure

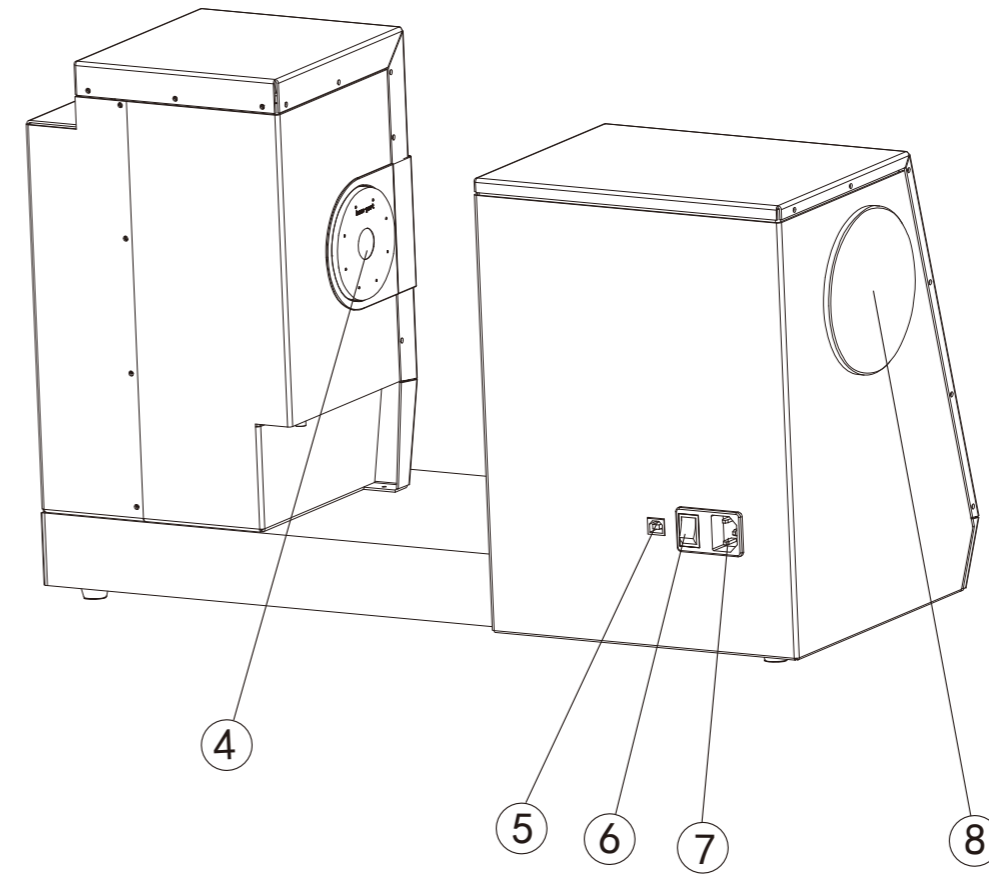
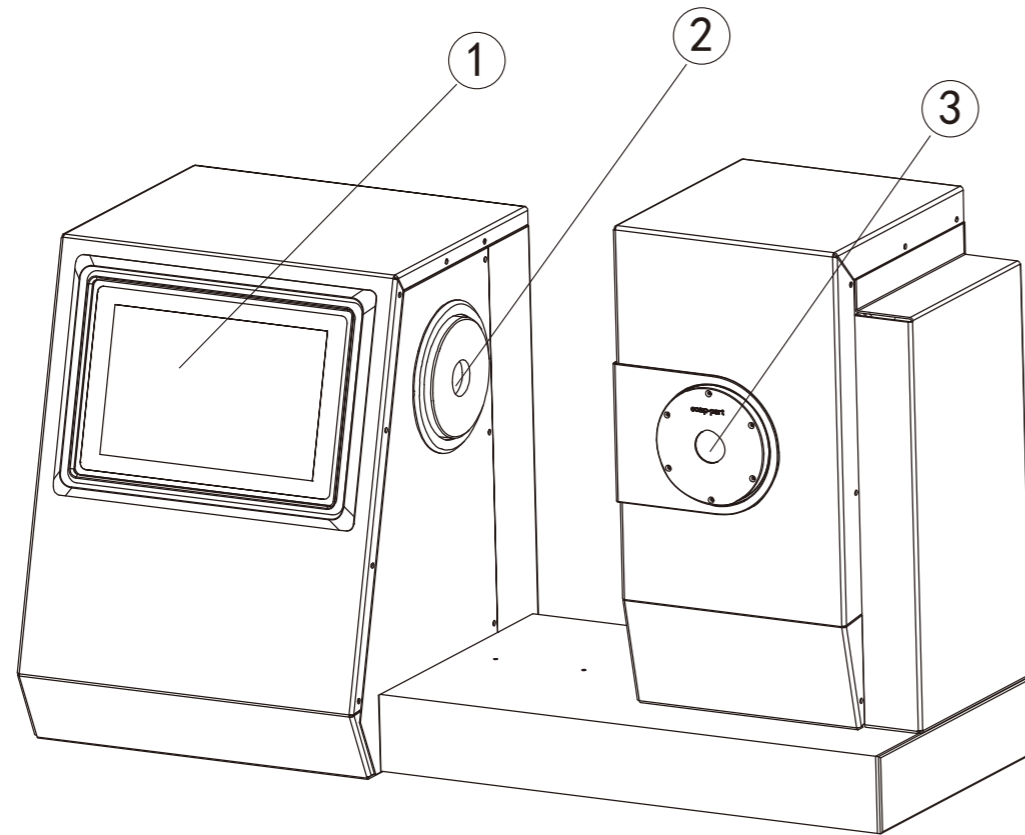

- ① Display Screen
- ② Light Exit Aperture
- ③ Compensation Aperture
- ④ Test Aperture
- ⑤ USB
- ⑥ Switch on-off
- ⑦ Power Interface
- ⑧ Light source exchnage port

Measurement flow chart

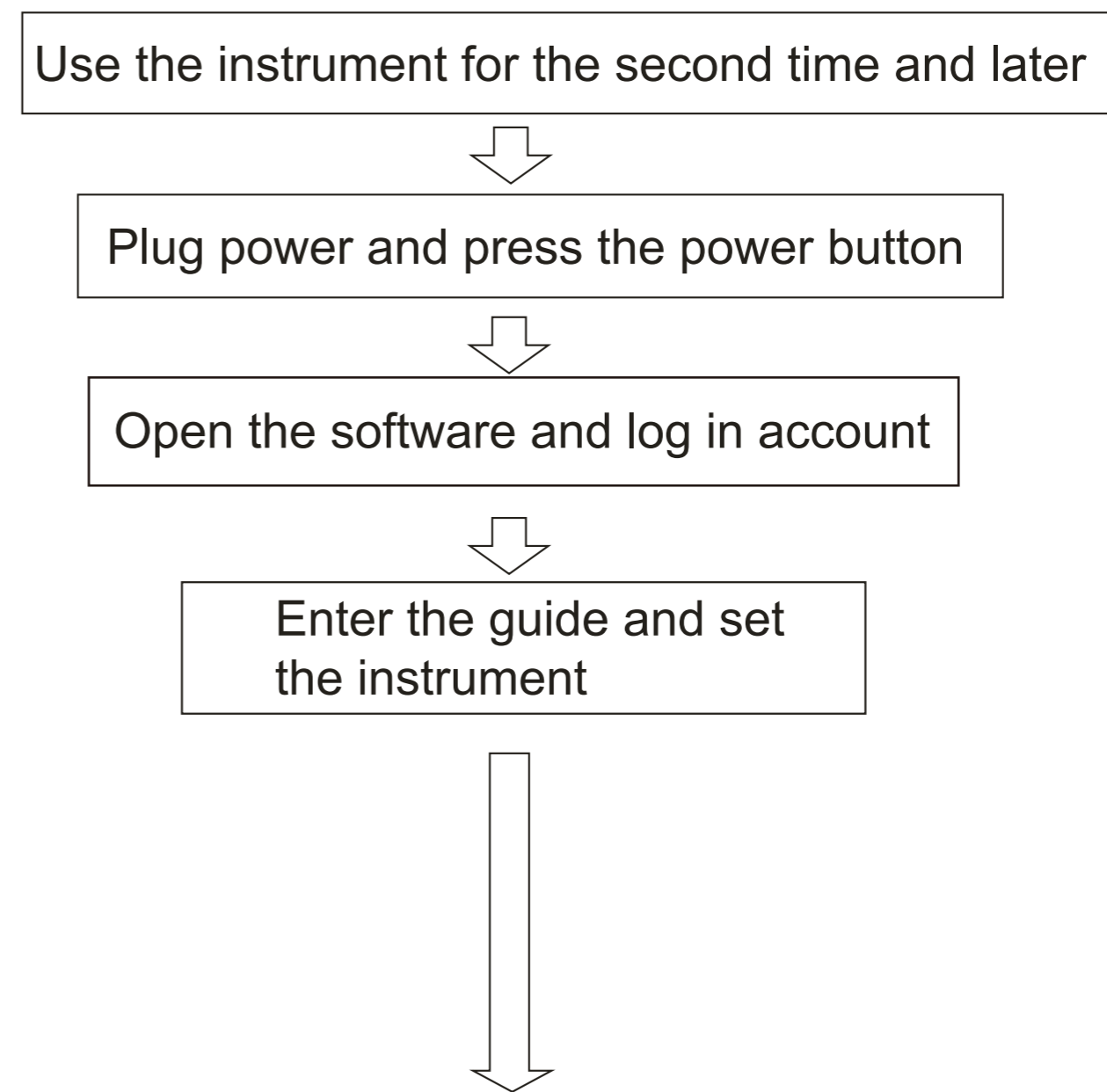
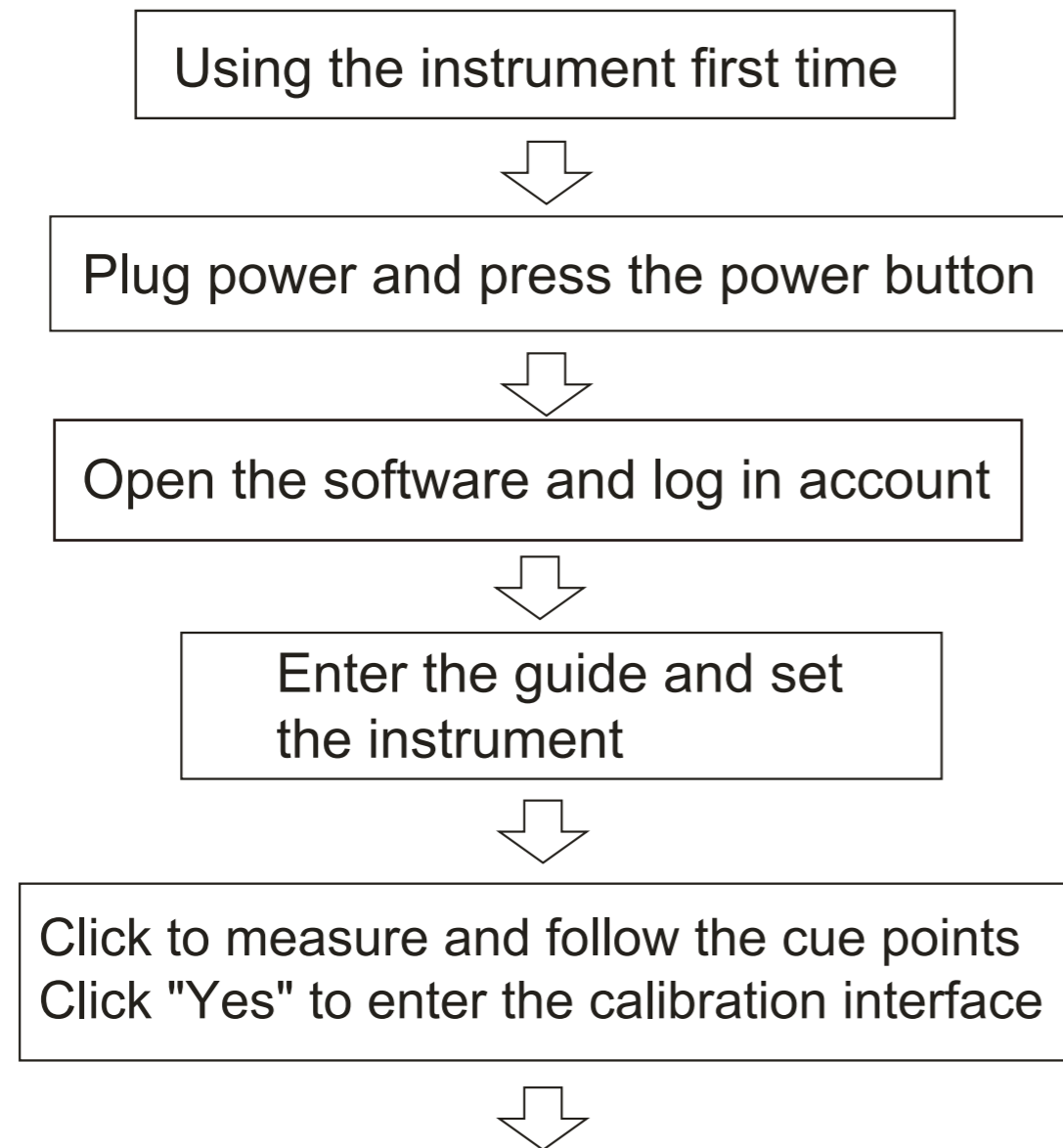

0% Calibration, 100% Calibration

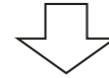

Target Measure and Sample Measure



Check measurement results

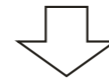

Save/not save the test result



Finish

Software interface introduction

[Features]

A-1

Main Interface

The software is divided into 8 modules, namely: calibration, measurement, setting, data browsing, personal center, about, log, update.

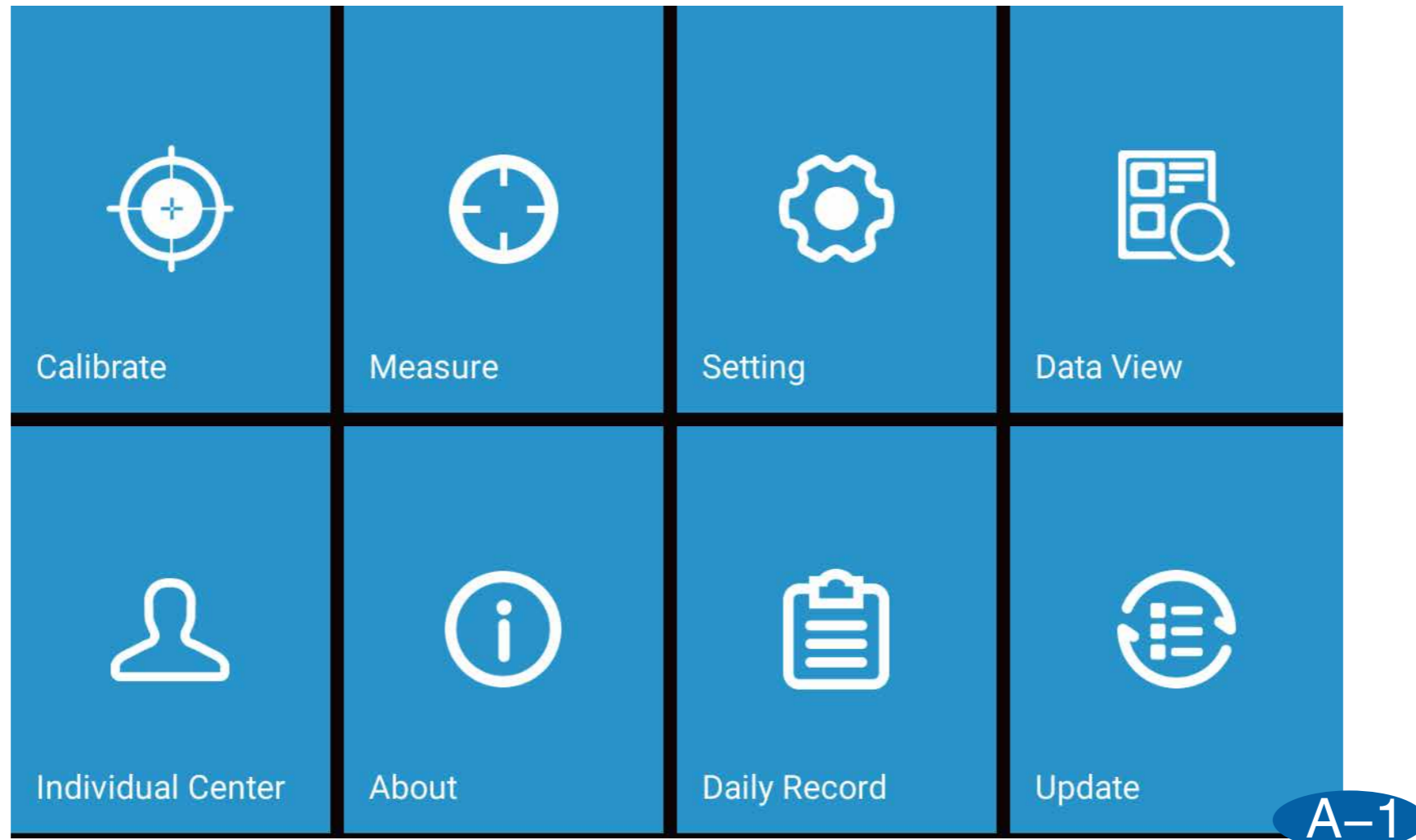

A-2

Title

From left to right, the title bar is: home button, measurement mode, light source and viewing angle.

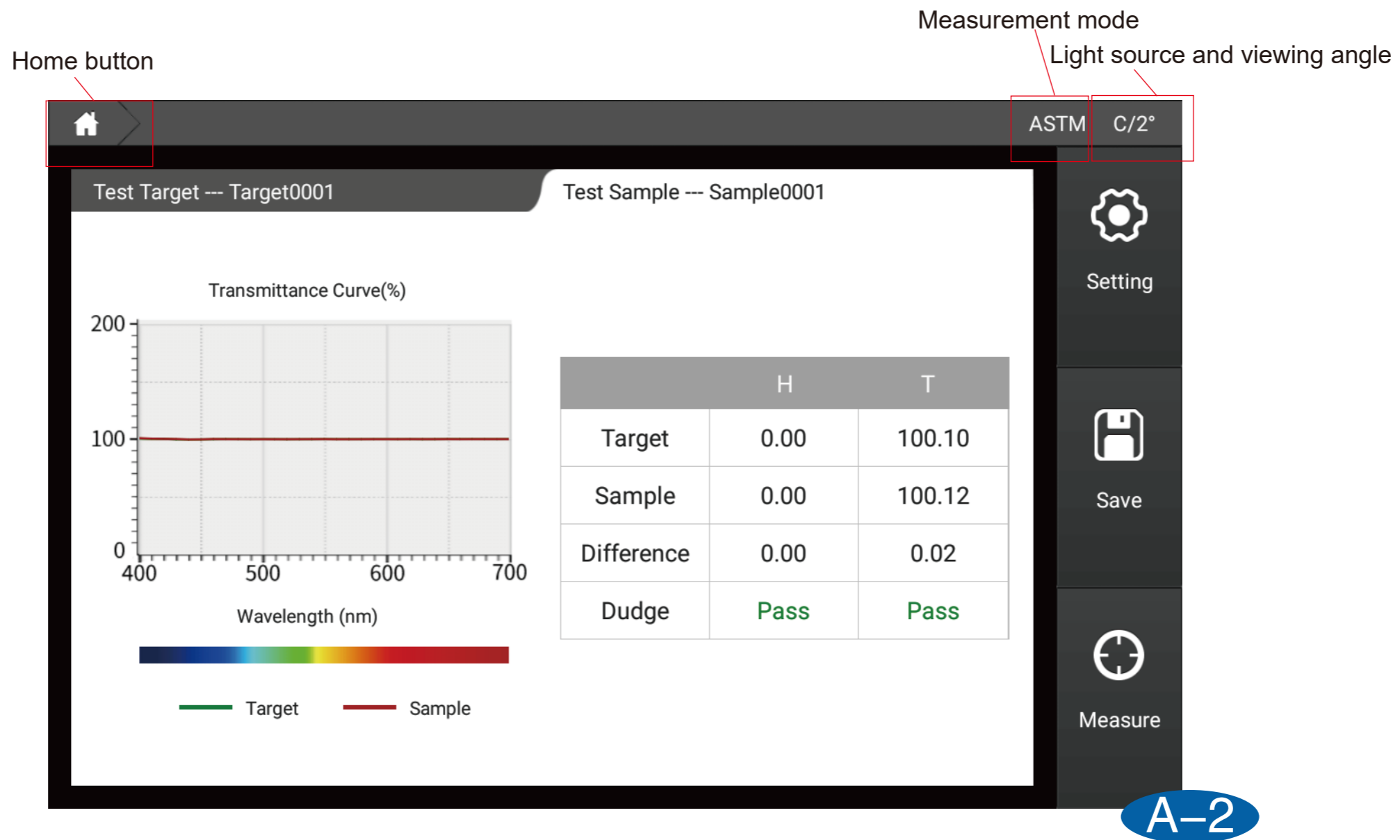

[Log In]

Login is divided into local login and network login. Check the Remember password, the account and password will be automatically entered when the next boot, check from The next time you start automatic login, you will skip the login page and go directly to the software.

B-1

The local login account is: admin, and the password is the instrument serial number by default (you can modify it in the personal center after login). For example, the instrument serial number is: C81118C0128, then enter C81118C0128 at the login password.

The screenshot shows a login page with a dark header. On the left, there is a 'Language' dropdown menu set to 'English'. On the right, there is a 'Wifi Setting' button. Below the header, there are two tabs: 'Login' (which is active) and 'Register'. The 'Login' section contains a dropdown menu for 'Local Login', a text input field with 'admin' entered, and a password input field with masked characters. Below the password field are two checkboxes: 'Keep Password' (checked) and 'Auto Login' (unchecked). A blue 'Login' button is positioned below the checkboxes. At the bottom right of the login section, there is a link for 'Forget Password?'.

B-1

B-2

Network Login

You need to connect to the Internet to log in to the Internet. Click Register to register your account. You can choose your email or mobile phone number to register. After the registration is completed, you can log in using the registered account. Use the network login to upload the stored data to the cloud, and perform data management on the windows.

The screenshot shows a web interface with a dark header. On the left, there is a 'Language' dropdown menu set to 'English'. On the right, there is a 'Wifi Setting' button. Below the header, there are two tabs: 'Login' and 'Register'. The 'Register' tab is active. The registration form consists of several input fields: 'Account', 'Company Name', 'Password', 'Address', 'Confirm Password', 'Name', 'Cell Phone', and 'Email'. At the bottom of the form, there are three buttons: 'Input Code', 'Get Code', and 'Register'.

B-2

[Guide]

C

After logging into the software for the first time or re-login after restoring the factory, you will enter the instrument use wizard, and you can set the instrument according to the wizard.

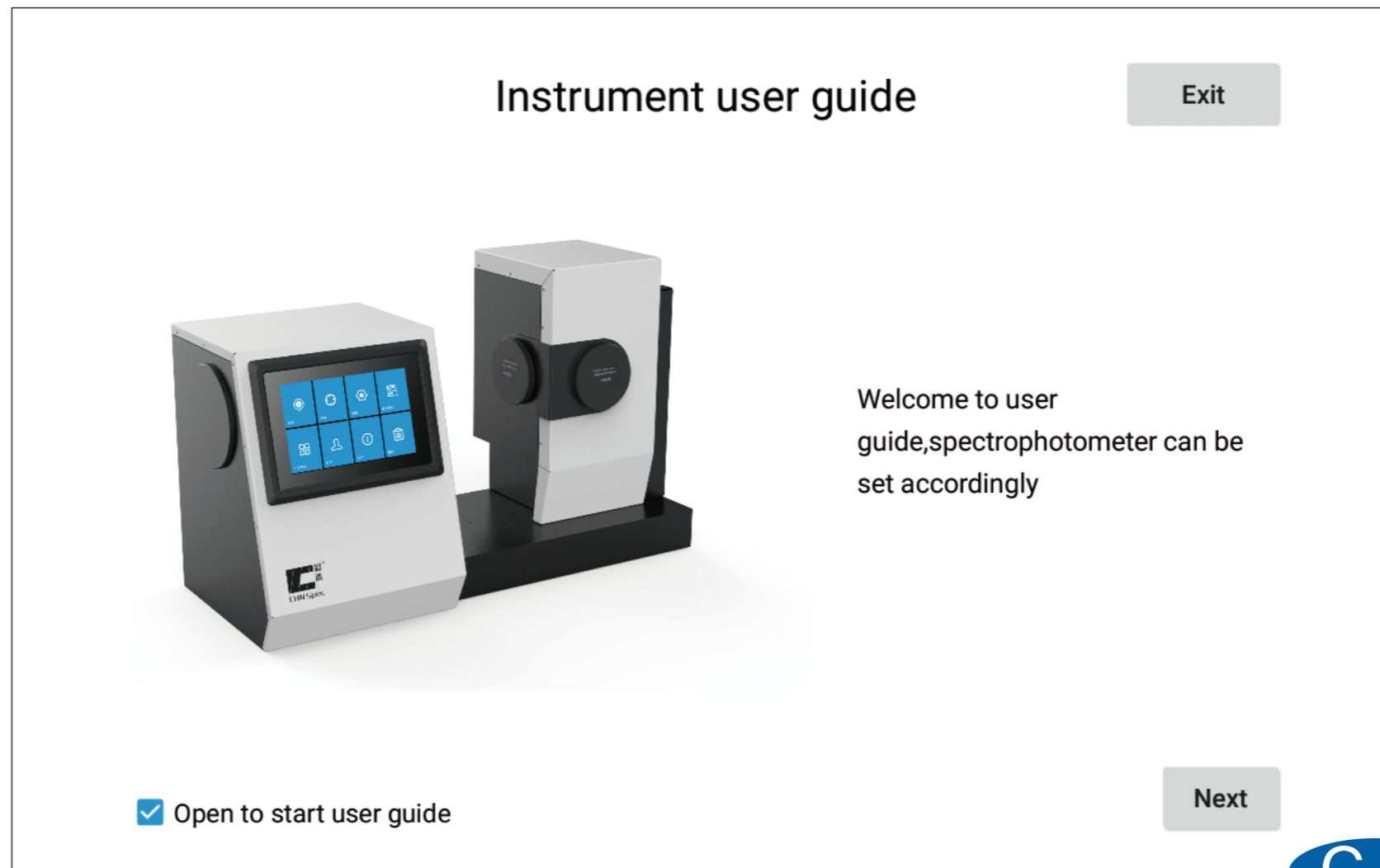

C-1

Instrument Setting

Exit

Mode Selection

ASTM

ISO

System Setting

Screen Light

Language English

Factory Reset

Screen Rotation

Wifi Setting

Timezone Setting

Previous

Next

1/5

C-2

Parameter Setting

Exit

Illuminant&Angle (The second illuminant is for calculating the metamerism)

First

C

2°

Second

A

2°

CMC(l:c)

l 2.0

c 1.0

CIE94

KL 1.0

KC 1.0

KH 1.0

CIE 2000

KL 1.0

KC 1.0

KH 1.0

2/5

Previous

Next

C-3

Tolerance Setting

Exit

Haze/T

CIE LAB&LCH

Hunter Lab

CIEDE2000

CIE LUV

CMC(l:c)&CIE94

Liquid

Temperature&Humidity

Haze/T

		Greater than	Less than	Between
dh(Haze) : ±	<input type="text" value="2.0"/>	<input type="button" value="Fail"/>	<input type="button" value="Fail"/>	<input type="button" value="Pass"/>
dt(T) : ±	<input type="text" value="2.0"/>	<input type="button" value="Fail"/>	<input type="button" value="Fail"/>	<input type="button" value="Pass"/>
dC : ±	<input type="text" value="2.0"/>	<input type="button" value="Fail"/>	<input type="button" value="Fail"/>	<input type="button" value="Pass"/>

3/5

Previous

Next

C-4

Other Settings

Exit

Average

Single Test Average Test

Save Setting

Manual Save Auto Save

Naming Rules

Target + Number + Date

Sample + Number + Date

4/5

Previous

Next

C-5

Display Setting

- H/T/C
- Haze/T**
- Haze
- Transmittance
- Clarity
- Color Diff.
- Data
- Figure
- Metamerism
- Liquid

5/5



Previous

Finish

C-6

[Calibration]

D-1

0% calibration

Perform 0% calibration according to the software prompt. In the ASTM mode, please cover the compensation port (comp-port) with the compensation port cap; in ISO mode, please keep the compensation port (comp-port) open.

This page can be used to set the calibration time. The default calibration valid time is 8 hours.

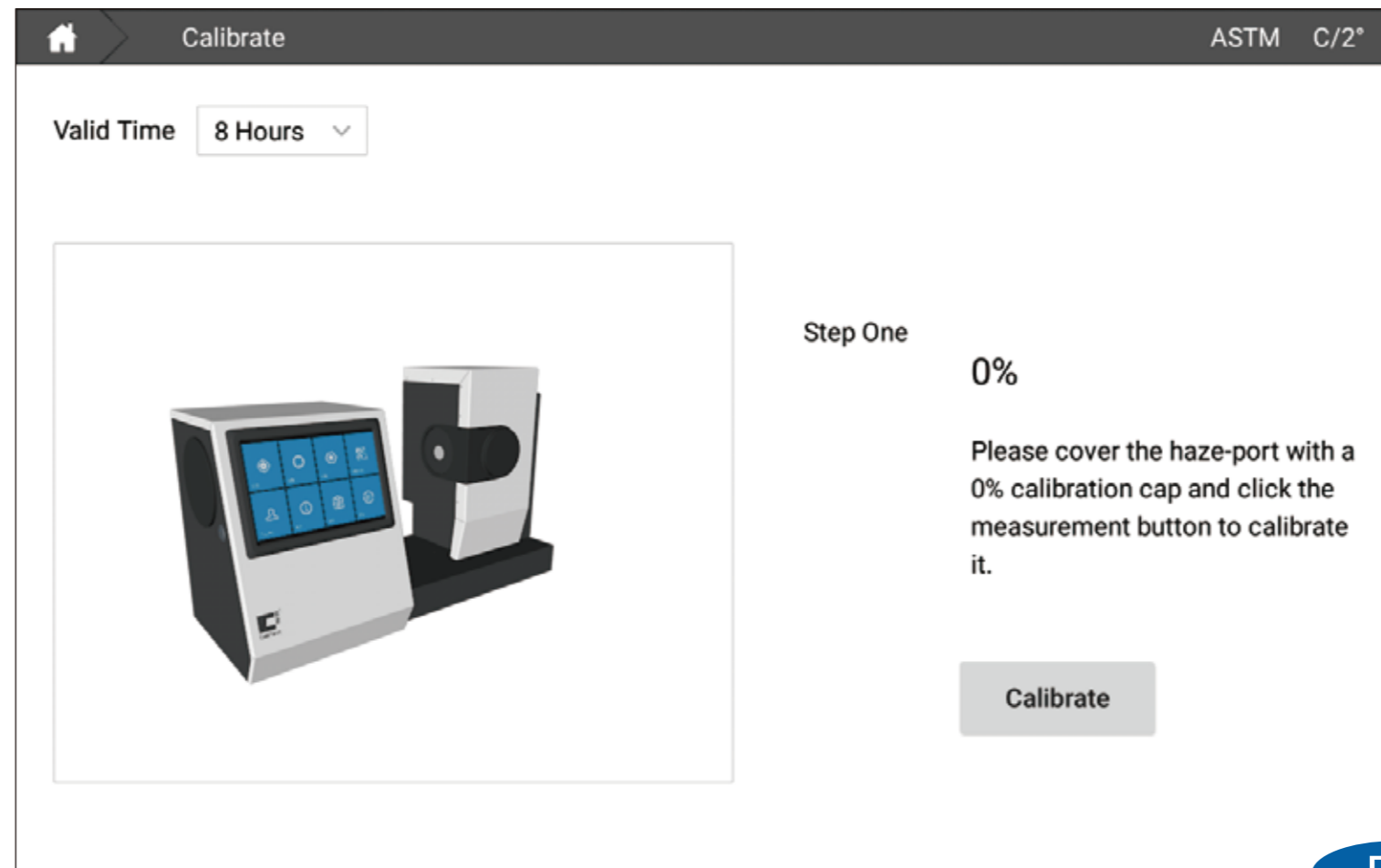

D-1

100% calibration

Perform 100% calibration as prompted by the software.

Home Calibrate ASTM C/2°

Valid Time 8 Hours

Step Two

100%

Keep haze-port aligned with the air and click the measurement button for calibration.

0% calibration succeed

Calibrate

Clarity calibration

Perform clarity calibration as prompted by the software.

The screenshot shows a software interface for clarity calibration. At the top, there is a dark header bar with a home icon, the word "Calibrate", and "ASTM C/2°". Below the header, on the left, is a "Valid Time" dropdown menu currently set to "8 Hours". In the center is a 3D illustration of a white and black instrument with a blue touchscreen. To the right of the illustration, the text reads "Step Three" followed by "Clarity Adjust". Below this, instructions state: "Please place the calibration sheet on the clarity-port and click the measurement button to calibrate the clarity". A green status message says "100% calibration succeed". At the bottom right of the instruction area is a grey "Calibrate" button.

[Measure]

The measurement is divided into three modes: standard sample measurement, sample measurement and other measurement modes (metamorphism, liquid color)

E-1

Standard measurement

Click Measure on the homepage to enter the standard sample measurement interface. After the sample is placed, click the measurement button in the lower right corner of the screen. The measurement data is displayed on the screen. The measurement button returns to the pressable state, indicating that the measurement is complete.

ASTM C/2°

Test Target --- Target0001

Test Sample

Setting

Save

Measure

Click to measure

H	T
0.00	100.05

E-1

E-2

Sample measurement

In the standard sample measurement interface, click the sample measurement on the interface to switch to the sample measurement interface. Similarly, after the sample is placed, click the measurement button in the lower right corner of the screen to perform sample data measurement.

The screenshot displays the 'Sample measurement' interface. At the top, it shows 'Test Target --- Target0001' and 'Test Sample --- Sample0001'. The main area contains a 'Transmittance Curve(%)' graph with 'Wavelength (nm)' on the x-axis (400 to 700) and percentage on the y-axis (0 to 200). A red line represents the 'Sample' and a green line represents the 'Target'. Below the graph is a color calibration bar. To the right of the graph is a data table:

	H	T
Target	0.00	100.05
Sample	0.00	100.07
Difference	0.00	0.02
Dudge	Pass	Pass

On the right side of the interface, there are three buttons: 'Setting' (gear icon), 'Save' (floppy disk icon), and 'Measure' (circular icon with a crosshair). The 'Measure' button is highlighted with a red box and labeled 'Click to measure'. A blue oval with 'E-2' is located at the bottom right of the interface.

[Setup]

The setting interface can configure the instrument measurement method, data calculation parameters, tolerance, software display, saving method, naming rules, average, etc. After modification, you need to click the "Apply" button.

F-1

Instrument settings

The instrument settings are divided into 6 areas:

1. Haze measurement mode: ASTM mode or ISO mode can be set;
2. System settings: You can set the screen backlight and language switch;
3. Factory reset: software configuration is restored to the initial state;
4. Screen rotation: Click on the screen to rotate the screen and the color will reverse 180°;
5. Wifi settings: you can choose WiFi and log in;
6. Time zone setting: time display in different countries, network can automatically synchronize time.

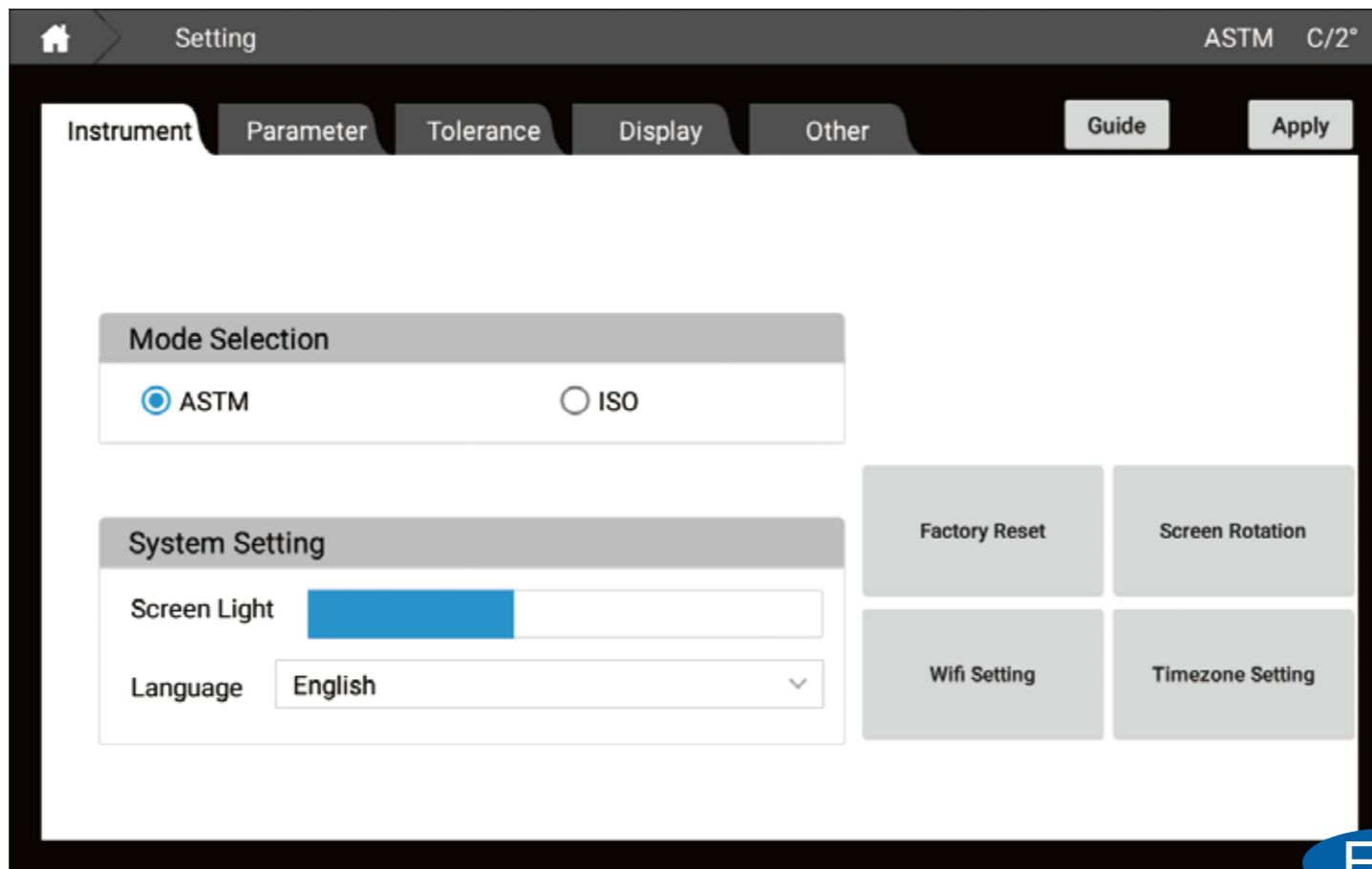

F-2

Parameter settings

Parameter setting can configure the data calculation

1. Light source & angle: You can set the light source and angle of the calculated data. The first light source and angle are the calculated data in all modes, and the second light source is only used to calculate the metamerism (Note: the data of the similar color search display is fixed at D65/ 10°)

- 2、CMC(l:c):L:c coefficient of CMC color difference formula can be set;
- 3、CIE 94:Can set KL, KC, KH coefficients of CIE94 color difference formula;
- 4、CIE 2000:Can set KL, KC, KH coefficients of CIE2000 color difference formula;

Setting ASTM C/2°

Instrument **Parameter** Tolerance Display Other Guide Apply

Illuminant&Angle (The second illuminant is for calculating the metamerism)

First C 2°

Second A 2°

CMC(l:c)

l 2.0 c 1.0

CIE94

KL 1.0 KC 1.0 KH 1.0

CIE 2000

KL 1.0 KC 1.0 KH 1.0

F-2

F-3

Tolerance settings

Tolerance is used to judge whether the measurement data is qualified. When the measurement data exceeds the tolerance range, the data will be disqualified. When the measurement data is less than or equal to the tolerance, the data will be prompted to be qualified. In this interface, you can set the tolerance of different color difference formulas and modes. (Where CIE LAB can customize the prompt language)

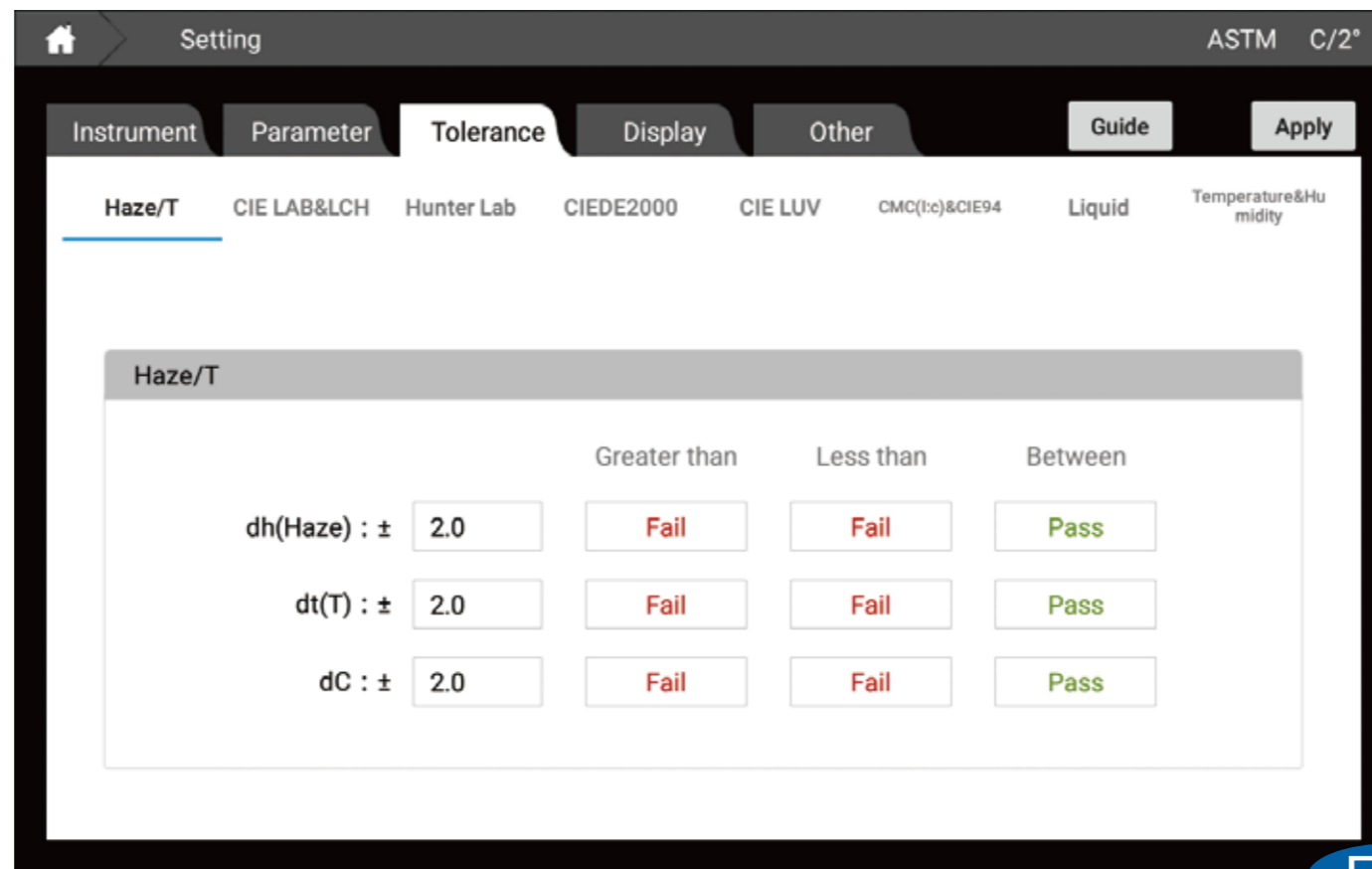

F-3

Display setting

Display settings can set the content displayed under "Measurement Page". Divided into the following:

1. Haze/transmittance/sharpness: display haze, total transmittance and sharpness parameters at the same time;
2. Haze/transmittance: Simultaneously display the parameters of haze and total transmittance;
3. Haze: Only display haze parameters;
4. Transmittance: Only the total transmittance parameter is displayed;
5. Clarity: only display the clarity parameter;
5. Color difference: CIELABCH, CIEDE2000, CIE94, CMC, HunterLab;
6. Data: This mode can display all parameters that can be measured by the instrument except haze and hiding power;
7. Image: CIE LAB diagram, Yxy diagram, Luv diagram, reflection/transmittance diagram, K/S curve diagram, absorbance curve diagram;
9. Metamerism: measure metamerism parameters;
10. Liquid color: measure saybolt, ASTM color, platinum-cobalt color, Gander color;

The screenshot shows a software interface for haze measurement. The main window has a top bar with a home icon, 'Setting', and 'ASTM C/2°'. Below this are tabs for 'Instrument', 'Parameter', 'Tolerance', 'Display', 'Other', 'Guide', and 'Apply'. A left sidebar lists measurement types: 'H/T/C', 'Haze/T' (highlighted), 'Haze', 'Transmittance', 'Clarity', 'Color Diff.', 'Data', 'Figure', 'Metamerism', and 'Liquid'. The main area contains an inset window titled '标样测量 - 标样0098' and '试样测量'. This inset window features a graph of '透过率曲线(%)' with a y-axis from 0 to 200 and an x-axis for '波长 (nm)' from 400 to 700. A horizontal line is drawn at 100% transmittance. To the right of the graph is a table:

雾度	总透过率
0.00	100.00

On the right side of the inset window, there are icons for '设置' (Settings), '保存' (Save), and '测量' (Measure).

F-6

Other settings

1. The average setting window can set single measurement or average measurement;
2. The save setting window can be set to save manually or automatically;
3. The naming rule window can set the naming rule when the standard sample is saved.

The screenshot displays the 'Setting' application interface. At the top, there is a home icon, the title 'Setting', and 'ASTM C/2°'. Below the title bar are tabs for 'Instrument', 'Parameter', 'Tolerance', 'Display', 'Other', 'Guide', and 'Apply'. The 'Other' tab is active. It contains three main sections:

- Average:** Two radio buttons: 'Single Test' (selected) and 'Average Test'.
- Save Setting:** Two radio buttons: 'Manual Save' (selected) and 'Auto Save'.
- Naming Rules:** Two rows. The first row is for 'Target' with a text input field containing 'Target' and two checkboxes: 'Number' (checked) and 'Date' (unchecked). The second row is for 'Sample' with a text input field containing 'Sample' and two checkboxes: 'Number' (checked) and 'Date' (unchecked).

F-6

[Data browsing]

G

1. The left side of the page shows the standard sample data list, and the right side shows the sample data list under the standard sample;
2. There is a search box on the left side of the page, click to search the target data;
3. After clicking one of the standard samples, you can see the detailed information of the sample data under the standard sample data on the right side of the interface;
4. Long press the standard sample or sample to choose to recall, modify, delete the current selection, delete all;
5. Click the standard sample to enter the sample detailed information interface, you can search for the sample under the current standard sample, and you can export the current display data;
6. Click Parameter Edit to pop up the parameter editing window, where you can select the parameters displayed on the data interface.

Standard search box

Standard data list

Target Search

Target0001

Edit	Name	L*	a*	b*	dE*ab	P/F dB
Target	Target0001	99.99	-0.09	-0.06	--	--

Test Search Name ▾ Search Export Export All

G-1

- Target Search
- Target0002
- Target0001

Edit	Name	L*	a*	b*	dE*ab	P/F dB
Target	Target0002	99.99	-0.06	-0.08	--	--
0	Sample0001	100.01	-0.05	-0.13	0.05	Pas

Sample data list

Can export the current display data and export all data

Test Search Name Search Export Export All

G-2

Home Data View ASTM C/2°

Target Search

Target0002

Target0001

Edit	Name	L*	a*	b*	dE*ab	P/F dE
Target	Target0002	99.99	-0.06	-0.08	--	--
0	Sample0001	100.01	-0.05	-0.13	0.05	Pas

Set Into Target

Revise

Delete Selected

Delete All

Test Search Name Search Export Export All

G-3

ASTM C/2°

Data View

Preferences

Color space value	L*	Selected parameters	L* a* b* dE*ab P/F dE*ab	TOP UP DOWN BOTTOM
Color space	a*			
Color difference	b*			
Whiteness	c*	ADD	FINISH	
Yellowness	h	DELETE		
Blackness	X	REMOVE ALL		
Transmittance	Y			
Color fastness	Z			
Force	x			
Color density				

G-4

[Personal center]

H-1

The personal center interface can modify the account password and cancel the current account.

The screenshot displays a web interface titled "Individual Center" with a home icon and "ASTM C/2°" in the top right. The interface is divided into two main sections:

- Account: admin**: This section contains four input fields for "Company Name", "Address", "Contact Name", and "Email".
- Change Password**: This section contains three input fields for "Old Password", "New Password", and "New Password Confirm", followed by an "Enter" button.

A "Logout" button is located at the bottom right of the interface.

H-1

[About]

I-1

About the interface, you can view the instrument information, such as software version, instrument version, instrument serial number, instrument model, etc.

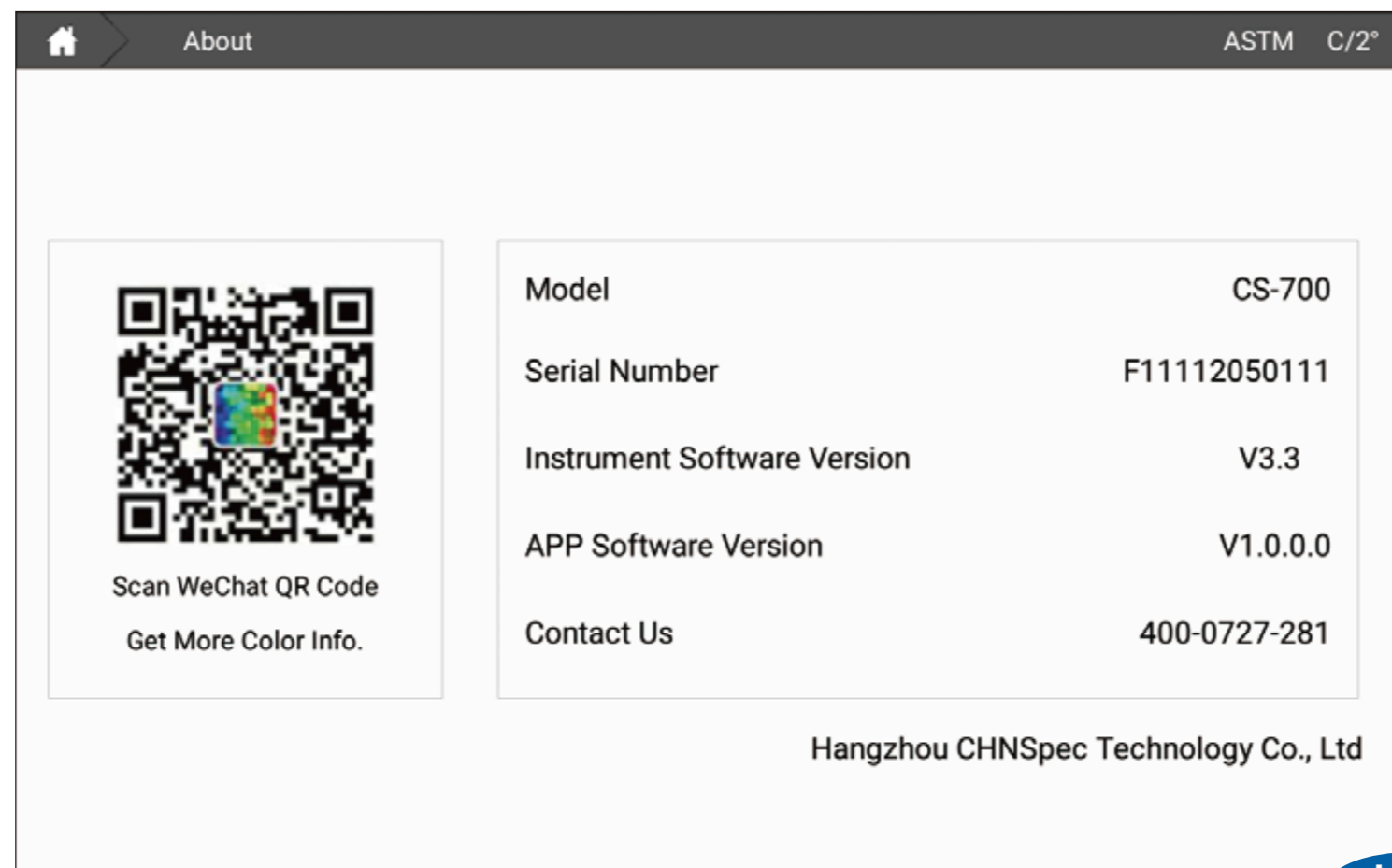

I-1

[Log]

J-1

On the log interface, you can see the instrument login information, calibration information, instrument error information, etc.

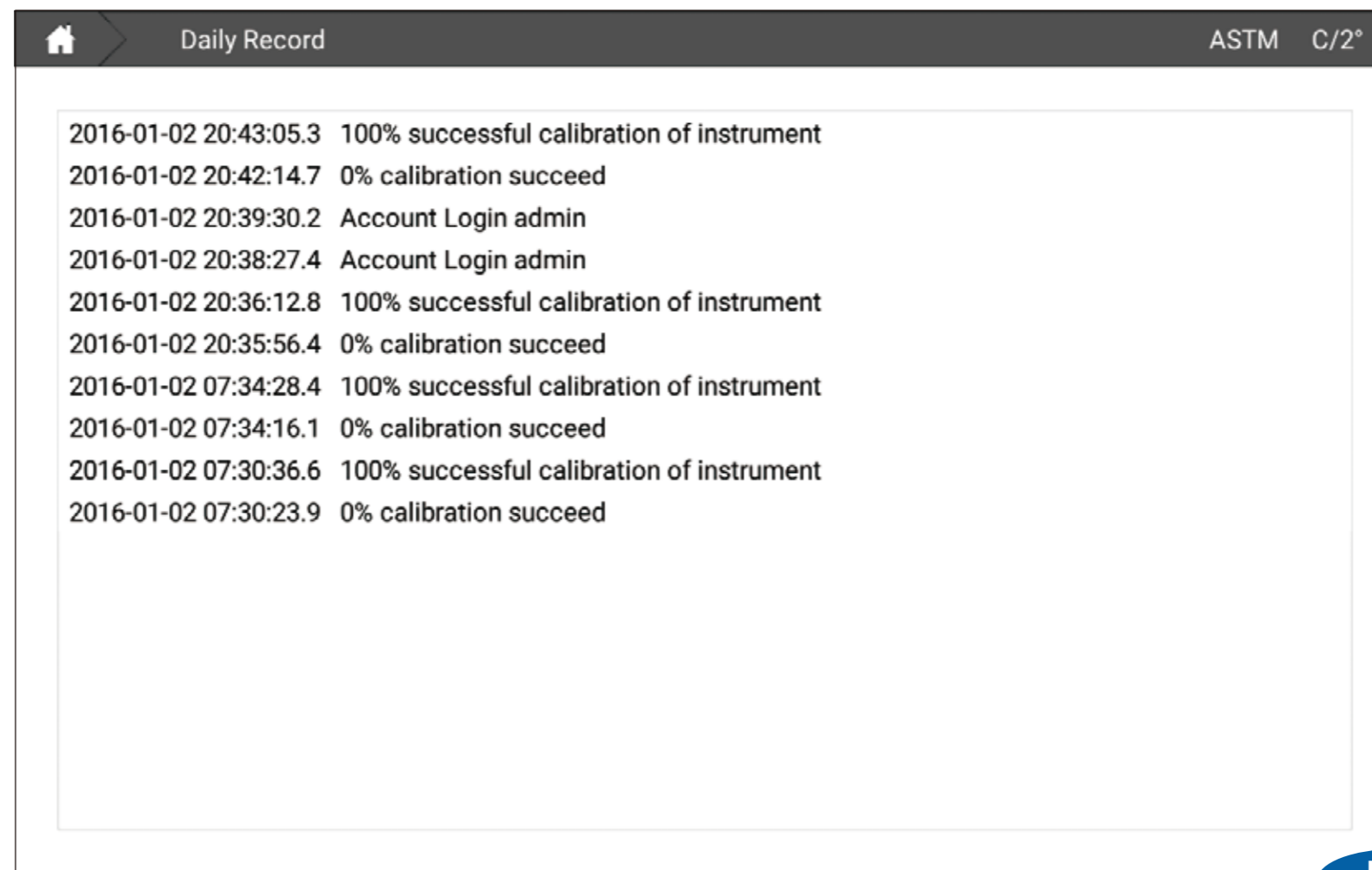

The screenshot shows a web interface titled 'Daily Record' with a home icon on the left and 'ASTM C/2°' on the right. The main content area contains a list of log entries:

2016-01-02 20:43:05.3	100% successful calibration of instrument
2016-01-02 20:42:14.7	0% calibration succeed
2016-01-02 20:39:30.2	Account Login admin
2016-01-02 20:38:27.4	Account Login admin
2016-01-02 20:36:12.8	100% successful calibration of instrument
2016-01-02 20:35:56.4	0% calibration succeed
2016-01-02 07:34:28.4	100% successful calibration of instrument
2016-01-02 07:34:16.1	0% calibration succeed
2016-01-02 07:30:36.6	100% successful calibration of instrument
2016-01-02 07:30:23.9	0% calibration succeed

J-1

[Update]

K-1

In the case of networking, you can click Update to detect whether there is new software to obtain the latest software.

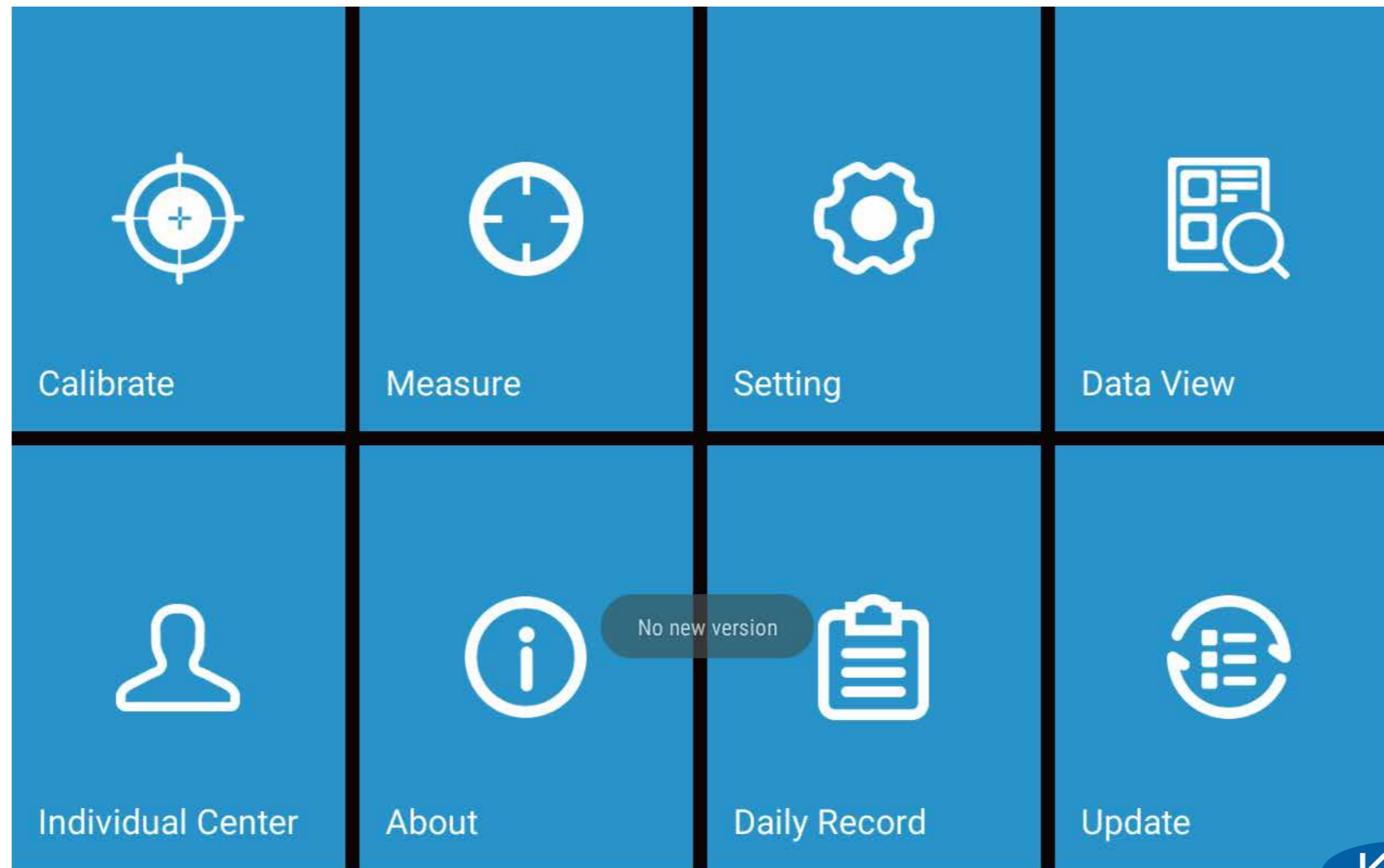

K-1

Introduction to the measurement interface

[Haze/transmittance/Clarity]

L-1

In this interface, the haze, total transmittance, sharpness and transmittance curve (%) can be displayed at the same time, and the difference between haze, total transmittance and sharpness can be calculated by comparing the standard samples, and passed simultaneously. The set tolerance automatically judges whether the sample is qualified.

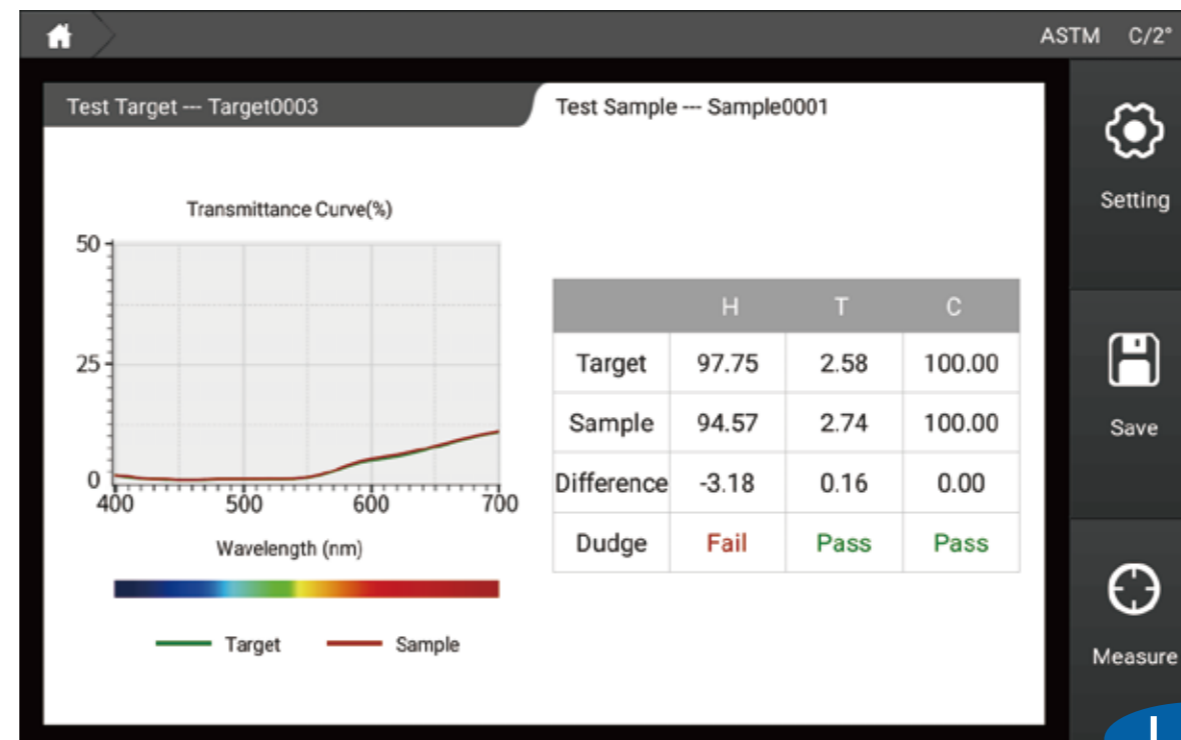

L-1

[Haze/transmittance]

M-1

In this interface, the haze, total transmittance and transmittance curve (%) can be displayed at the same time, the difference between haze and total transmittance is calculated by comparing the standard sample, and the tolerance is automatically set at the same time Determine whether the sample is qualified.

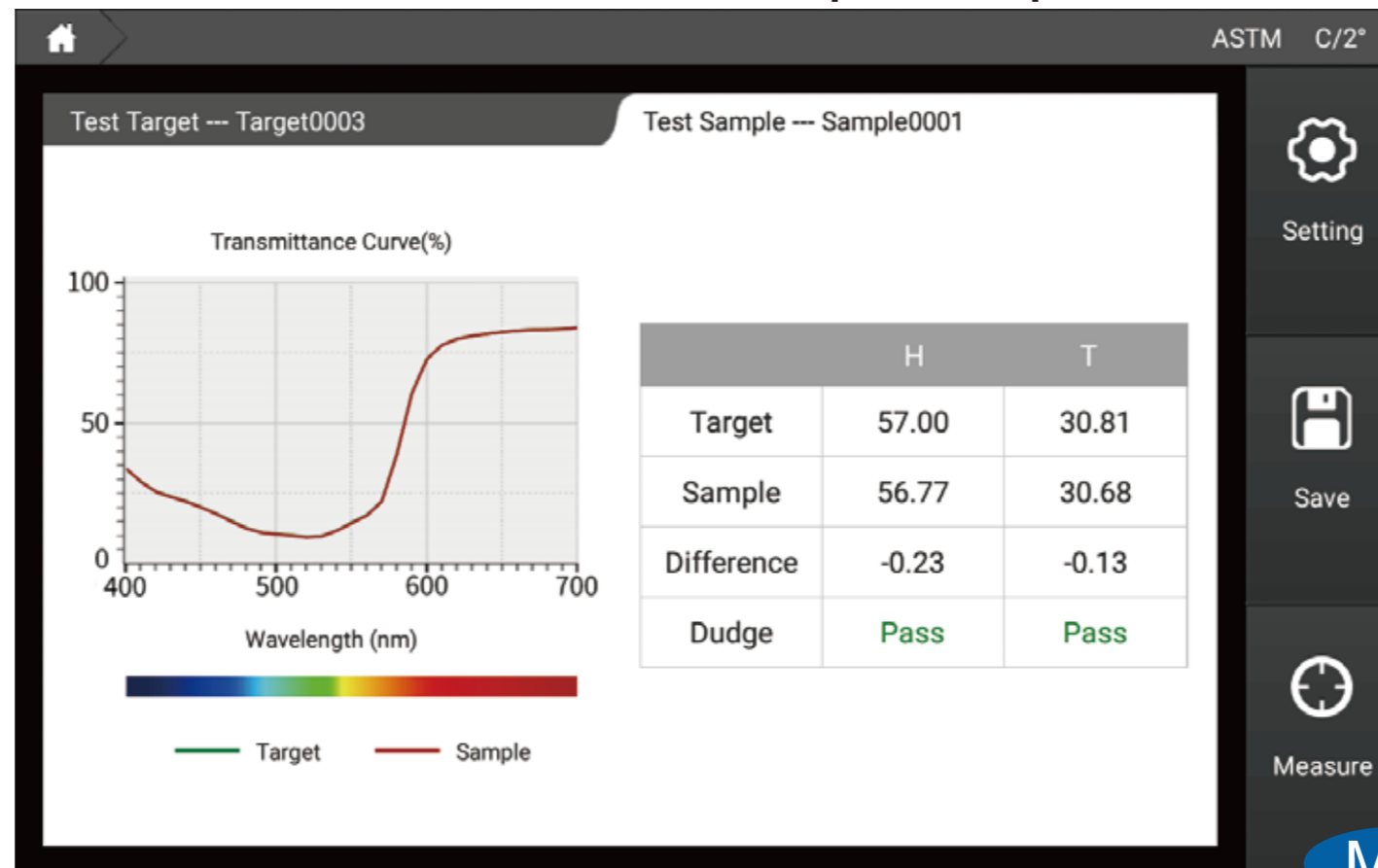

M-1

[Haze]

M-1

In this interface, only the haze and transmittance curves (%) are displayed, and the difference in haze is calculated by comparing the standard sample, and at the same time, the sample is automatically judged by the set tolerance.

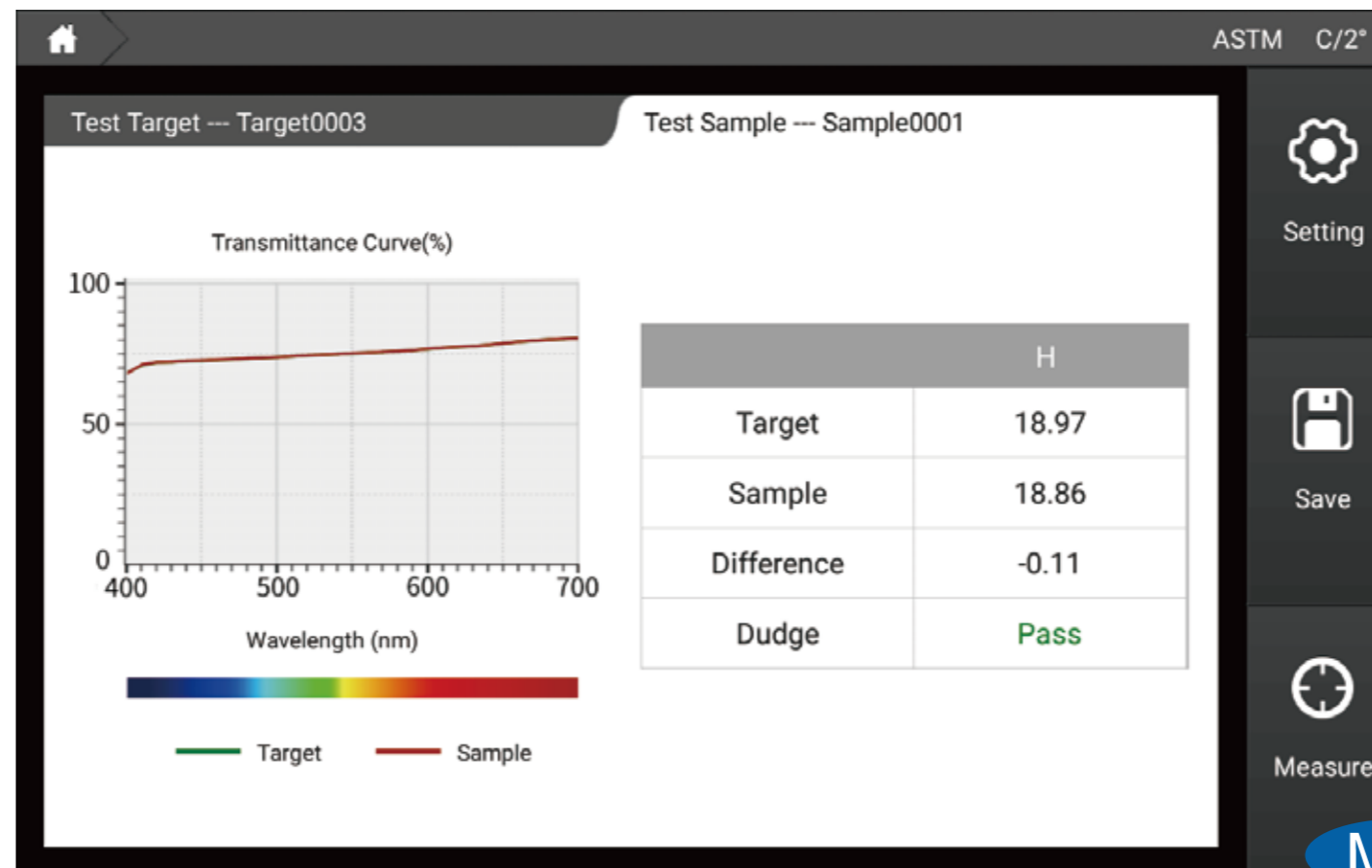

M-1

[Transmittance]

N-1

On this interface, only the total transmittance and transmittance curve (%) are displayed. The difference in total transmittance is calculated by comparing the standard sample, and the sample is automatically judged by the set tolerance.

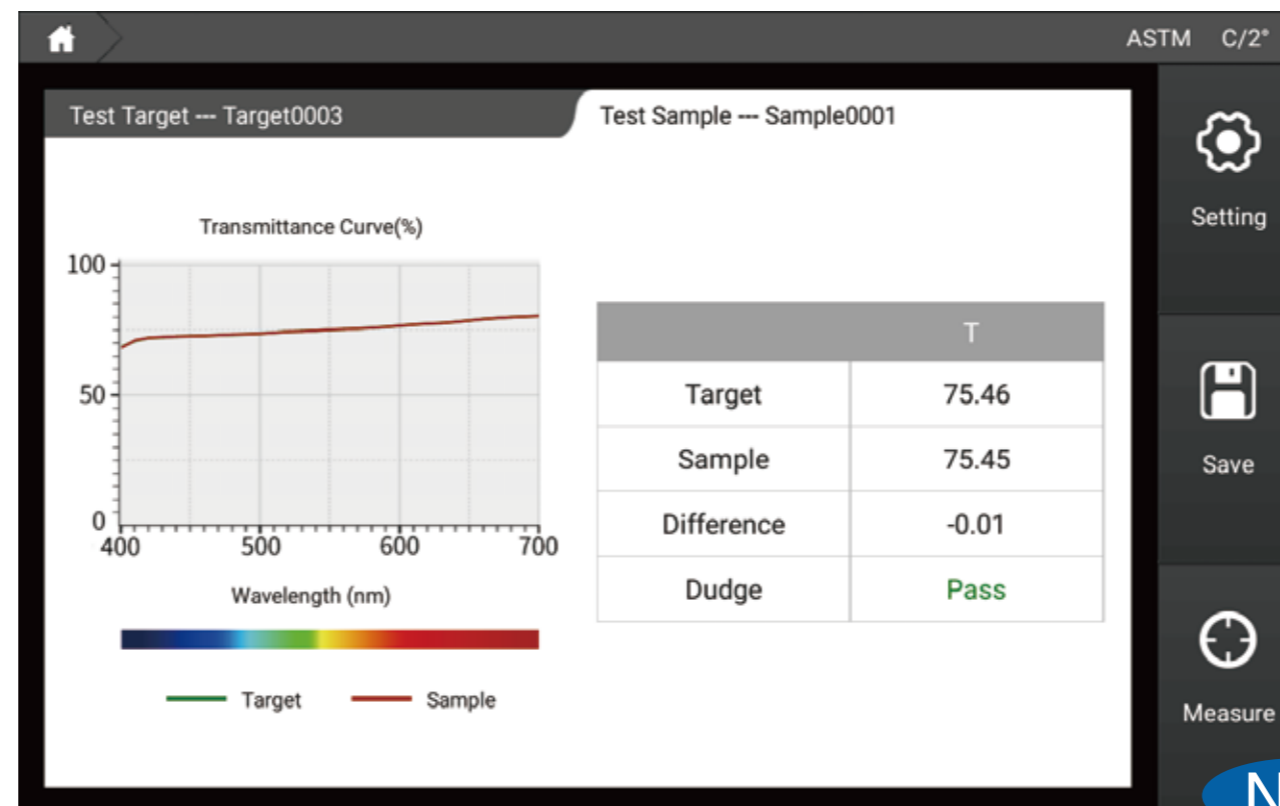

N-1

[Clarity]

0-1

In this interface, only the clarity is displayed, the difference in sharpness is calculated by comparing the standard sample, and the sample is automatically judged by the set tolerance.

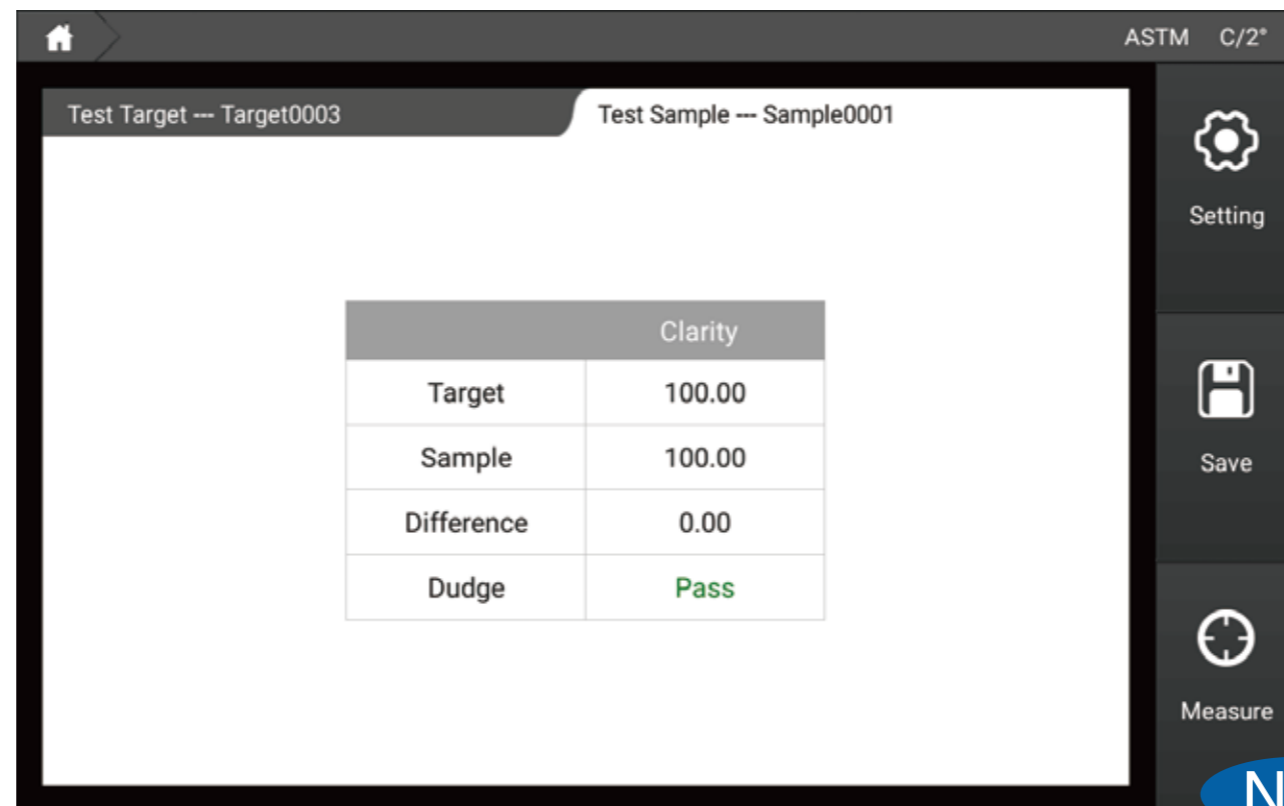

	Clarity
Target	100.00
Sample	100.00
Difference	0.00
Dudge	Pass

N-1

[Color difference]

P-1

CIELABCH

In this interface, the L^* , a^* , b^* , c^* , h values of the sample color can be measured, and the dL^* , da^* , db^* , dc^* , dH^* , dE^*_{ab} are calculated by comparing with the standard sample. At the same time, automatically determine whether the sample is qualified by the set tolerance.



Test Target --- Target0003

Test Sample --- Sample0001

Target

L* = 18.87
a* = 18.46
b* = 18.03
c* = 25.81
h = 44.34

Sample

L* = 19.03
a* = 18.56
b* = 17.25
c* = 25.34
h = 42.91

dL* = 0.15 Pass
da* = 0.10 Pass
db* = -0.78 Pass
dc* = -0.47 Pass
dH* = -0.64 Pass

dE*ab
0.81 Pass



Setting



Save



Measure

0-1

P-2

CIEDE2000

In this interface, the L^* , a^* , b^* , c^* , h values of the sample color can be measured, and the dL' , dC' , dH' , and dE^*2000 can be displayed by comparing with the standard sample calculation, and at the same time through the setting The tolerance of automatically determines whether the sample is qualified.

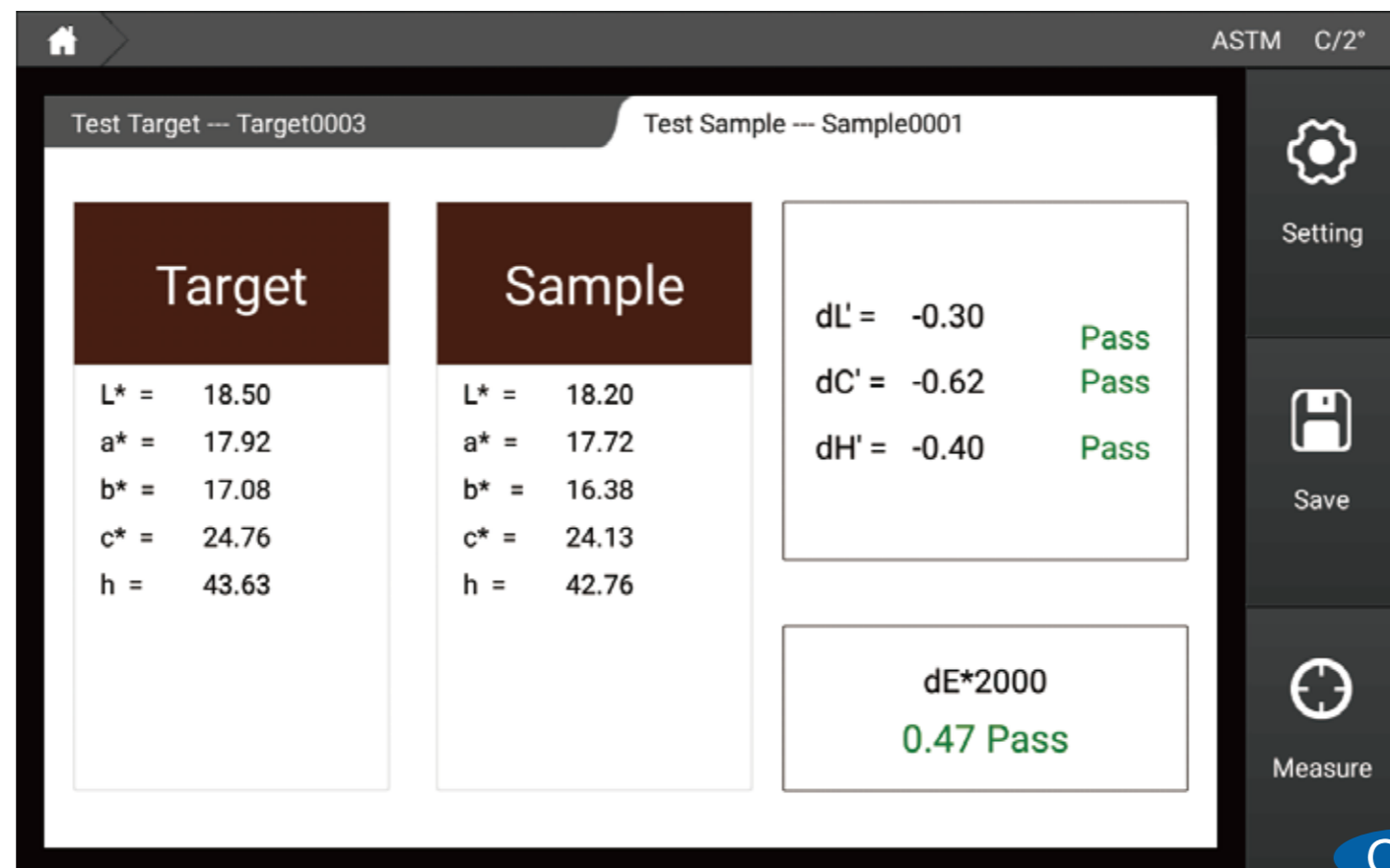

O-2

CIE94

In this interface, the L^* , a^* , b^* , c^* , h values of the sample color can be measured, and the dL^* , da^* , db^* , dc^* , dH^* , and dE^* are calculated by comparing with the standard sample. 94. At the same time, it automatically judges whether the sample is qualified by the set tolerance.

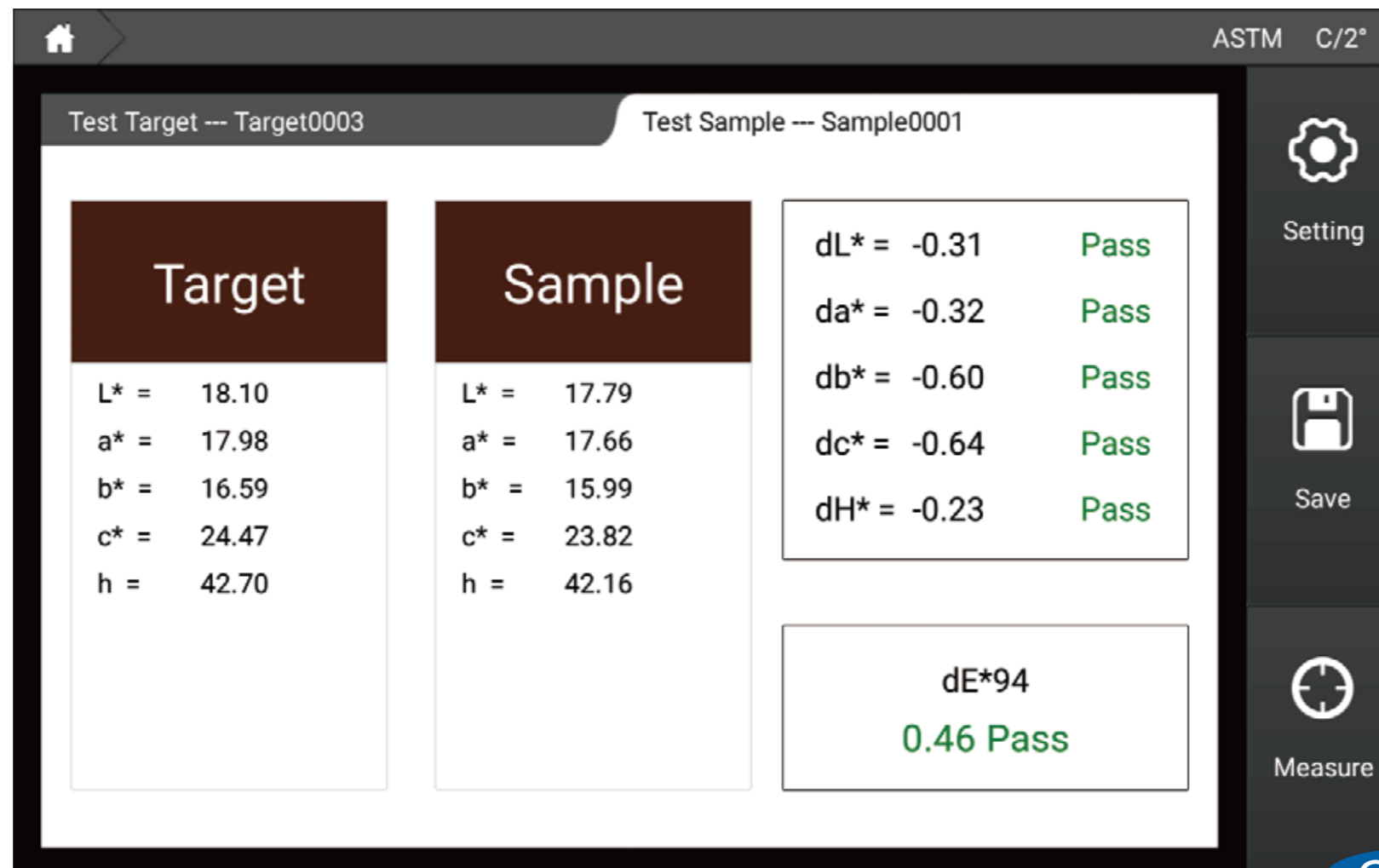

P-4

CMC

In this interface, the L^* , a^* , b^* , c^* , h values of the sample color can be measured, and the dL^* , da^* , db^* , dc^* , dH^* , and $dE_{cmc}(l:c)$, at the same time automatically determine whether the sample is qualified by the set tolerance.

The screenshot displays a software interface for color measurement. At the top, it shows 'ASTM C/2°'. Below this, there are two tabs: 'Test Target --- Target0003' and 'Test Sample --- Sample0001'. The interface is divided into three main sections:

- Target Data:**

L^*	=	18.33
a^*	=	18.35
b^*	=	16.26
c^*	=	24.52
h	=	41.55
- Sample Data:**

L^*	=	18.32
a^*	=	18.51
b^*	=	16.65
c^*	=	24.90
h	=	41.97
- Difference and Pass/Fail Status:**

dL^*	=	-0.01	Pass
da^*	=	0.16	Pass
db^*	=	0.39	Pass
dc^*	=	0.38	Pass
dH^*	=	0.18	Pass
$dE_{cmc}(2.0:1.0)$			
0.30 Pass			

On the right side of the interface, there are three buttons: 'Setting' (gear icon), 'Save' (floppy disk icon), and 'Measure' (crosshair icon).

O-4

P-5

Hunter Lab

In this interface, the values of Hunter L, Hunter a, and Hunter b of the sample color can be measured, and dHunter L, dHunter a, dHunter b, and dEab can be calculated by comparing with the standard sample. At the same time, whether the data is automatically determined by the set tolerance qualified.

The screenshot displays the Hunter Lab software interface. At the top, it shows 'ASTM C/2°'. Below this, there are two tabs: 'Test Target --- Target0003' and 'Test Sample --- Sample0001'. The interface is divided into three main sections:

- Target (Hunter):** L = 15.99, a = 11.51, b = 7.24
- Sample (Hunter):** L = 15.92, a = 11.51, b = 7.23
- Comparison Results:**
 - dL = -0.07 Pass
 - da = -0.00 Pass
 - db = -0.00 Pass
 - dEab: 0.07 Pass

On the right side, there is a vertical toolbar with three icons: a gear for 'Setting', a floppy disk for 'Save', and a crosshair for 'Measure'.

[Data]

Q-1

1. In the data interface, you can click parameter edit to select the parameter you want to see;
2. Check the parameter difference of the sample by measuring the standard sample and then measuring the sample;
3. Click on the data to select it, and long press on the data to delete and rename the data.

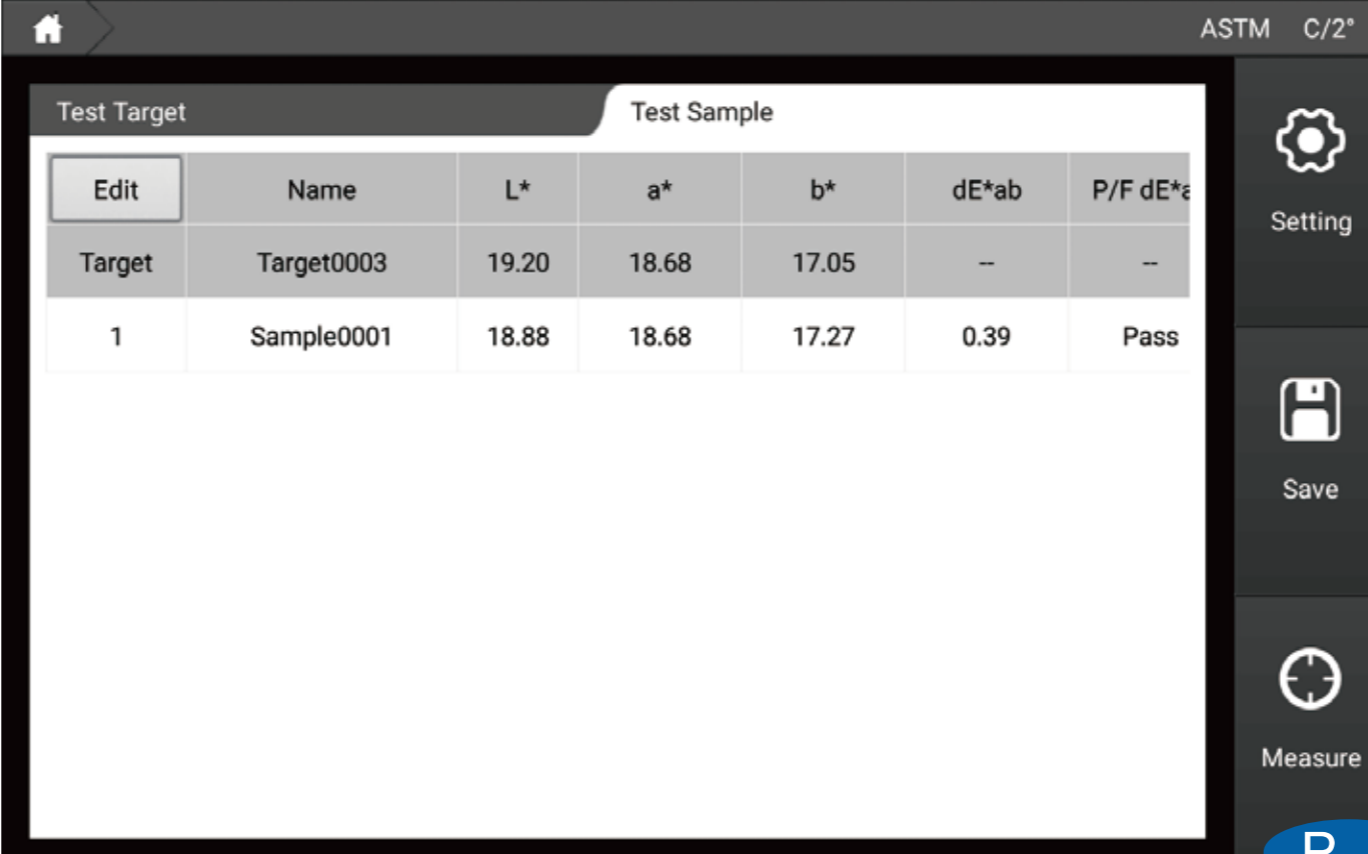

ASTM C/2°

Edit	Name	L*	a*	b*	dE*ab	P/F dE*ab
Target	Target0003	19.20	18.68	17.05	--	--
1	Sample0001	18.88	18.68	17.27	0.39	Pass

Setting

Save

Measure

P-1

[Figure]

R-1

CIELAB

In this interface, you can measure the L^* , a^* , and b^* values of the sample, and at the same time use the a^* and b^* values of the sample to trace points on the CIELAB graph and display the L^* , a^* , and b^* values of the data.

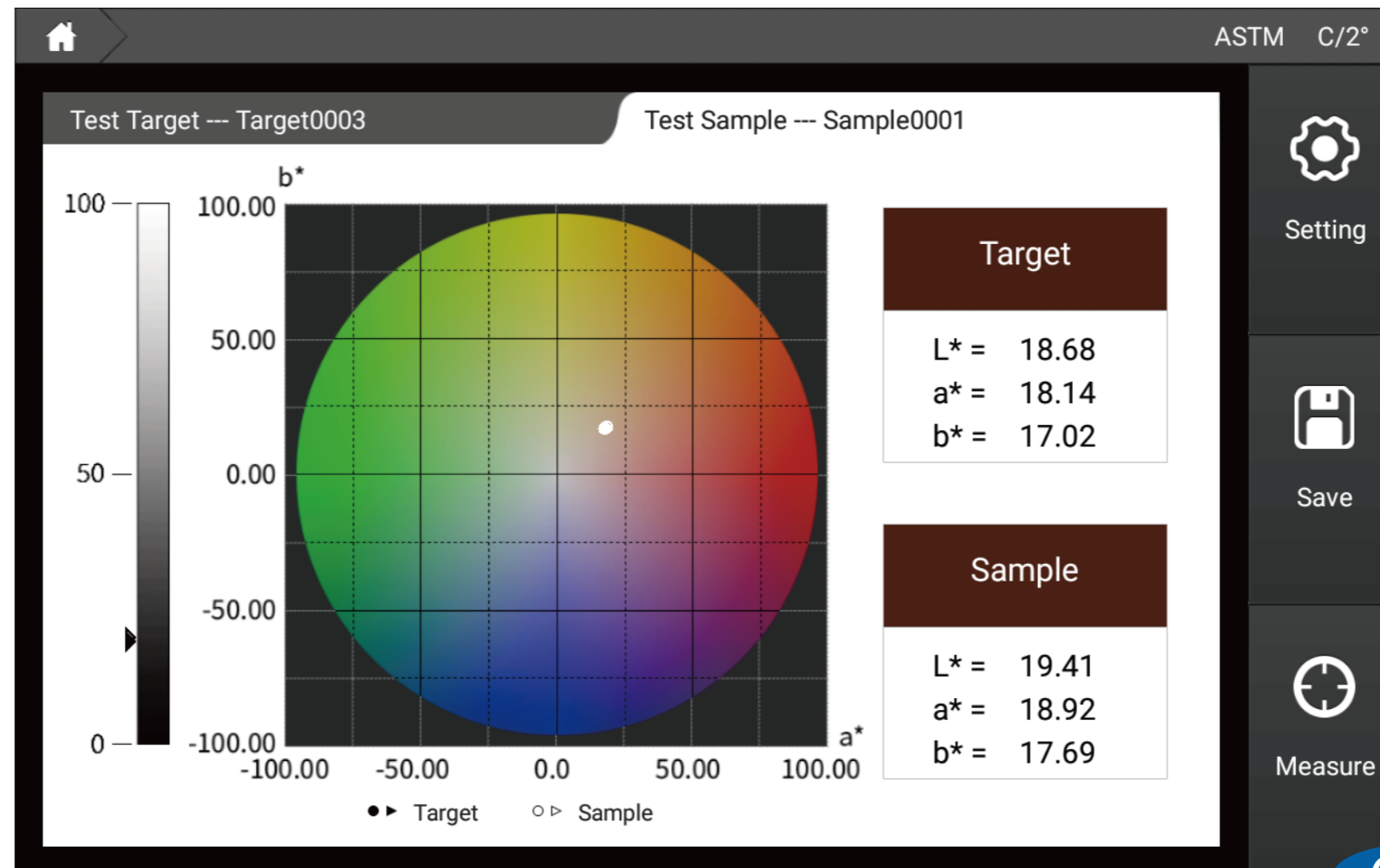

R-2

Yxy

In this interface, you can measure the Y, x, and y values of the sample, and use the x and y values of the sample to trace points on the Yxy graph and display the Y, x, and y values of the data.

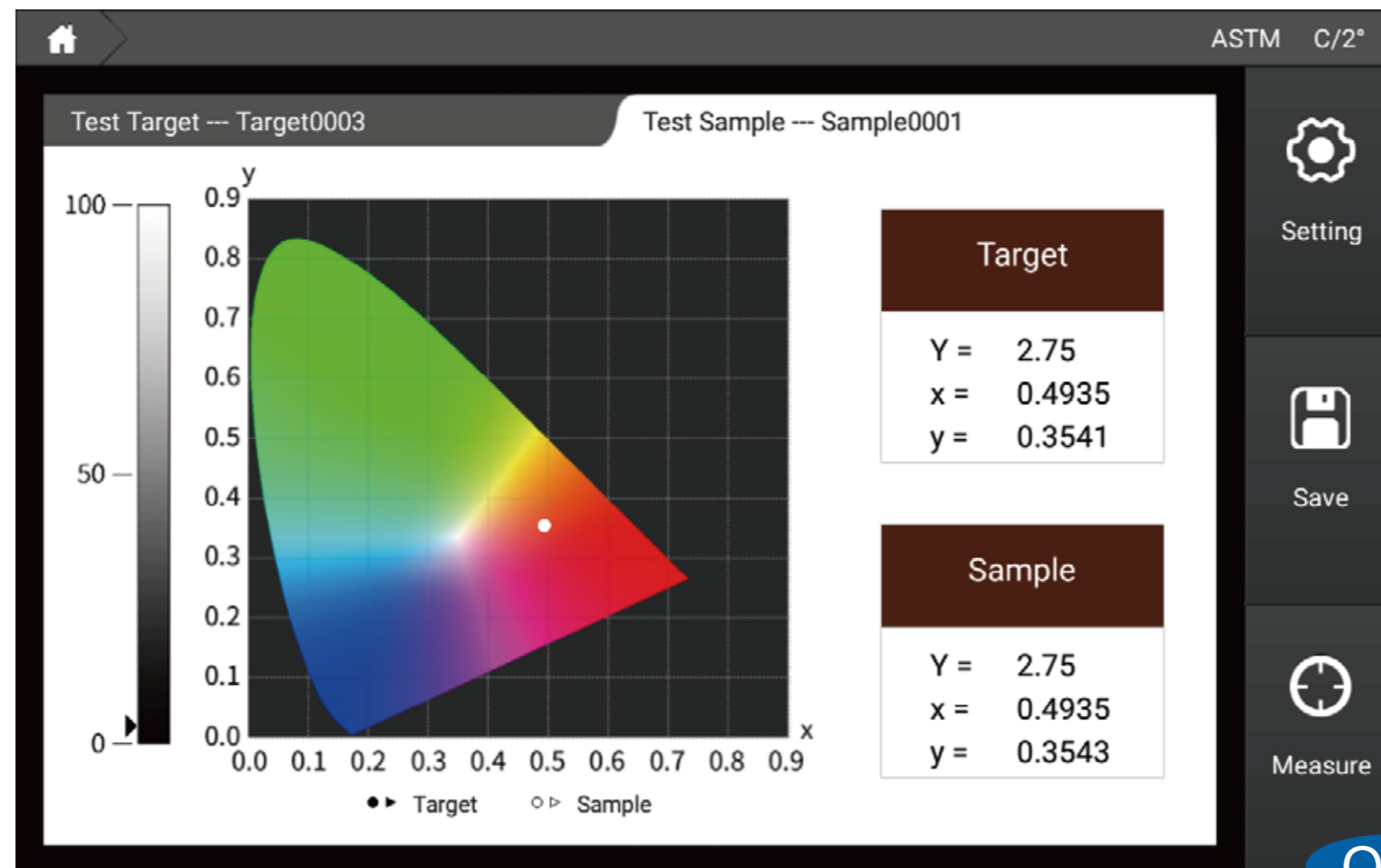

Q-2

R-3

Luv

In this interface, you can measure the L^* , u^* , and v^* values of the sample, and use the u' and v' values of the sample to trace points on the Luv chart and display the L^* , u^* , and v^* values of the data.

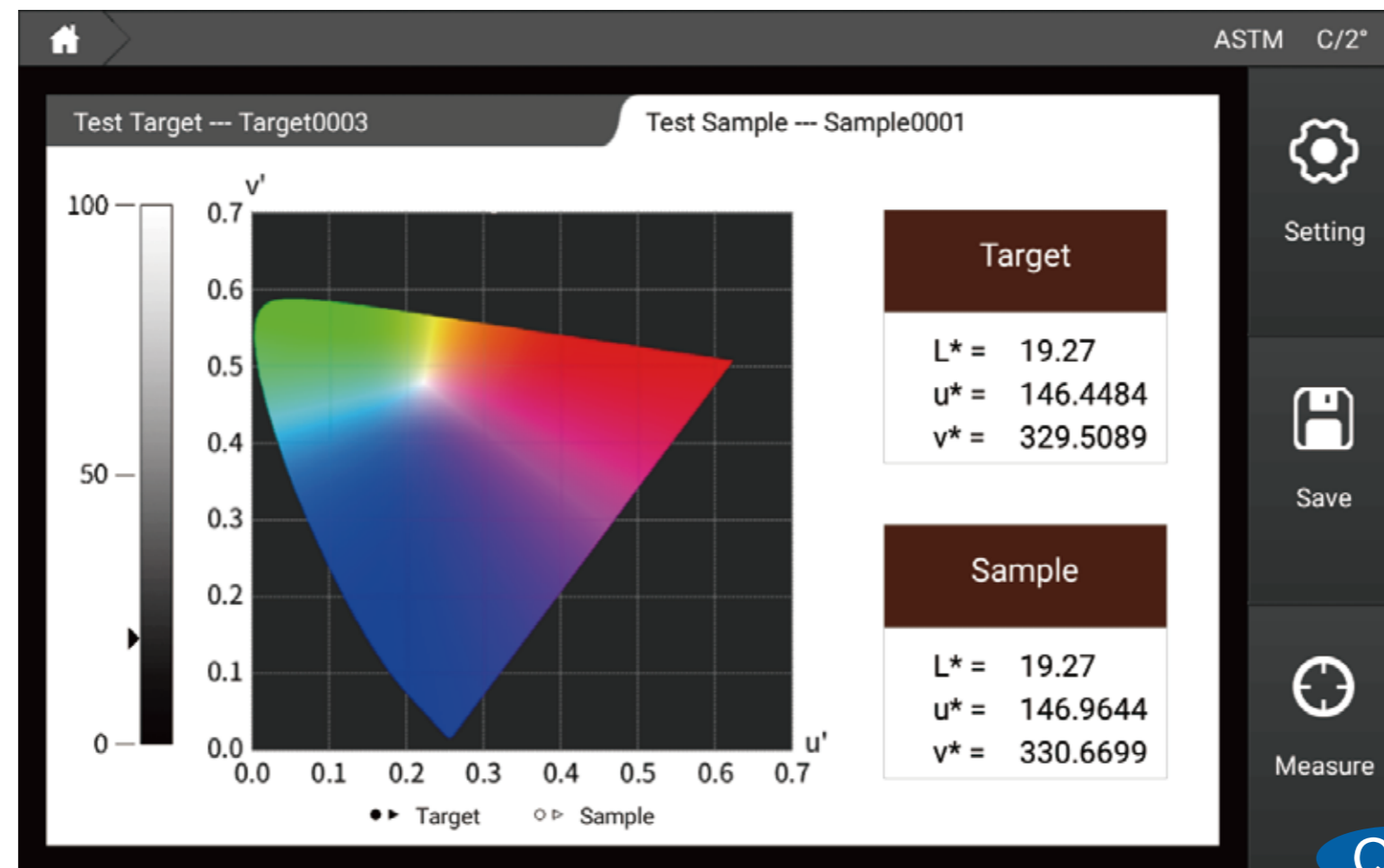

R-4

k/s curve

In this interface, the k/s value of the sample can be measured, and the K/S curve under 360-780nm is displayed at the same time.

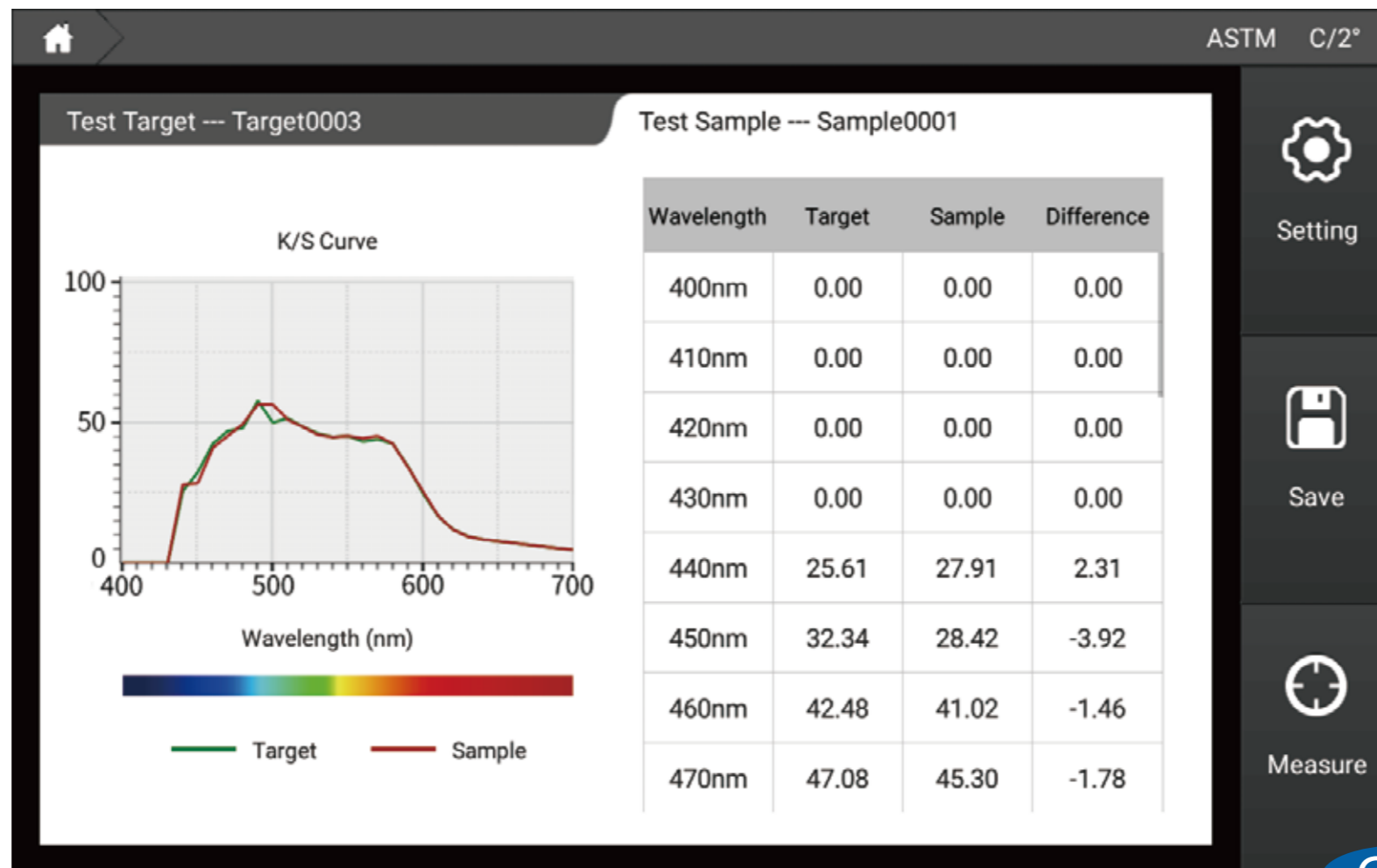

Q-4

R-5

Transmittance curve

In this interface, the transmittance value of the sample can be measured, and the transmittance curve under 360-780nm can be displayed.

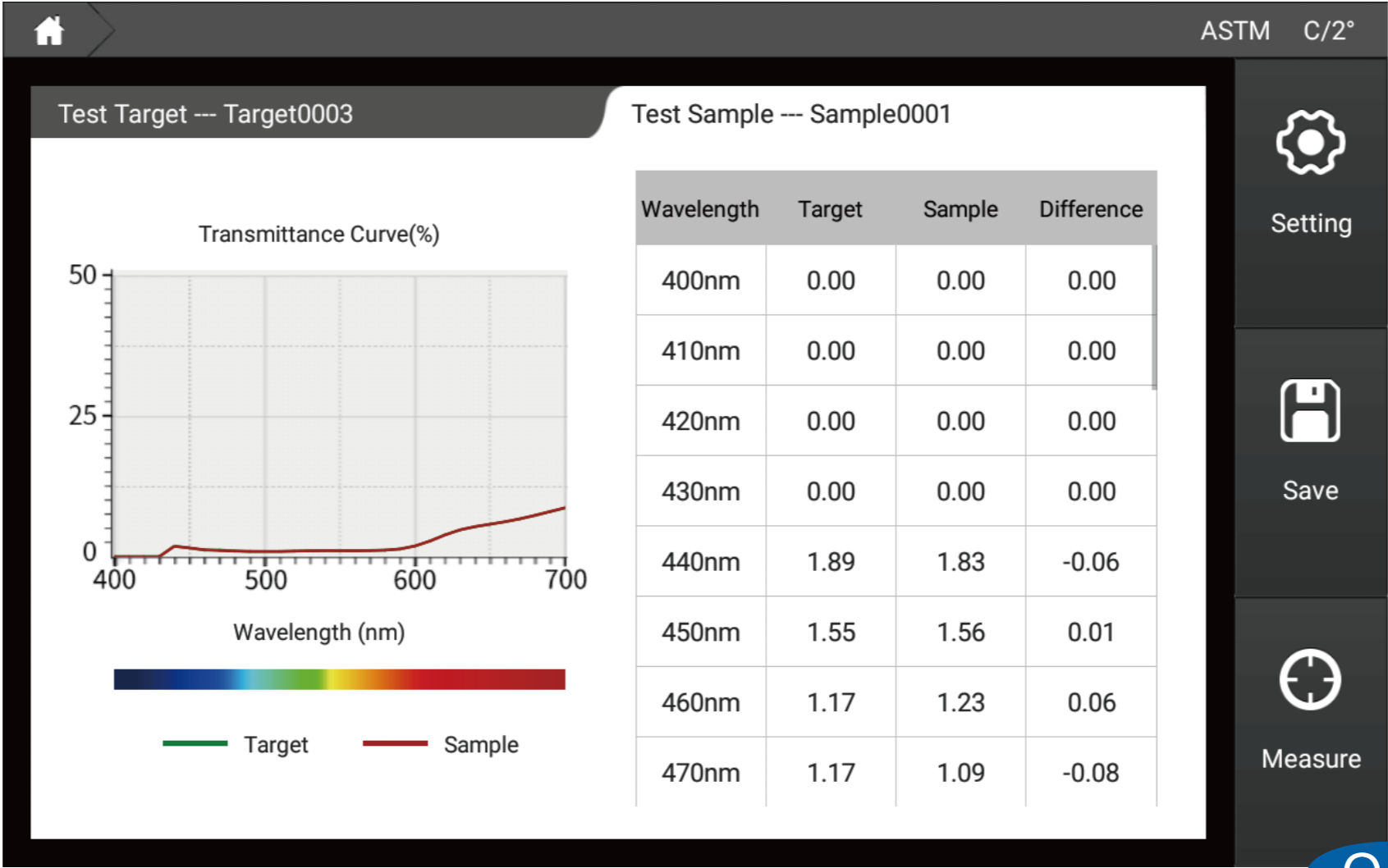

R-6

Absorbance curve

In this interface, the absorbance value of the sample can be measured, and at the same time, the absorbance curve under 360-780nm can be displayed.

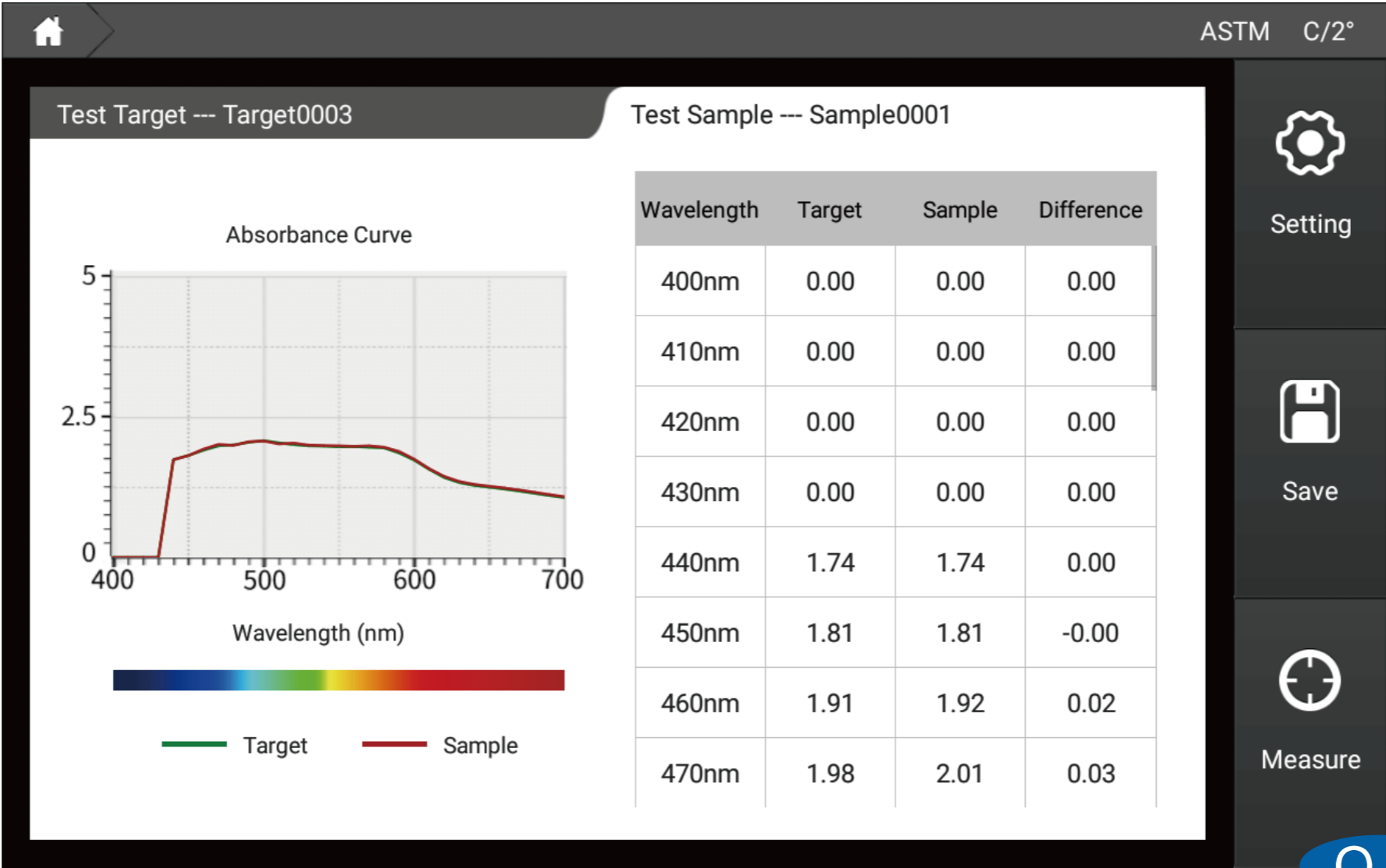

[Metamerism]

S-1

The left side of the interface is the value calculated by the measurement sample using the first light source/angle, and the right side is the value calculated by the measurement sample using the second light source/angle. Metamerism values.

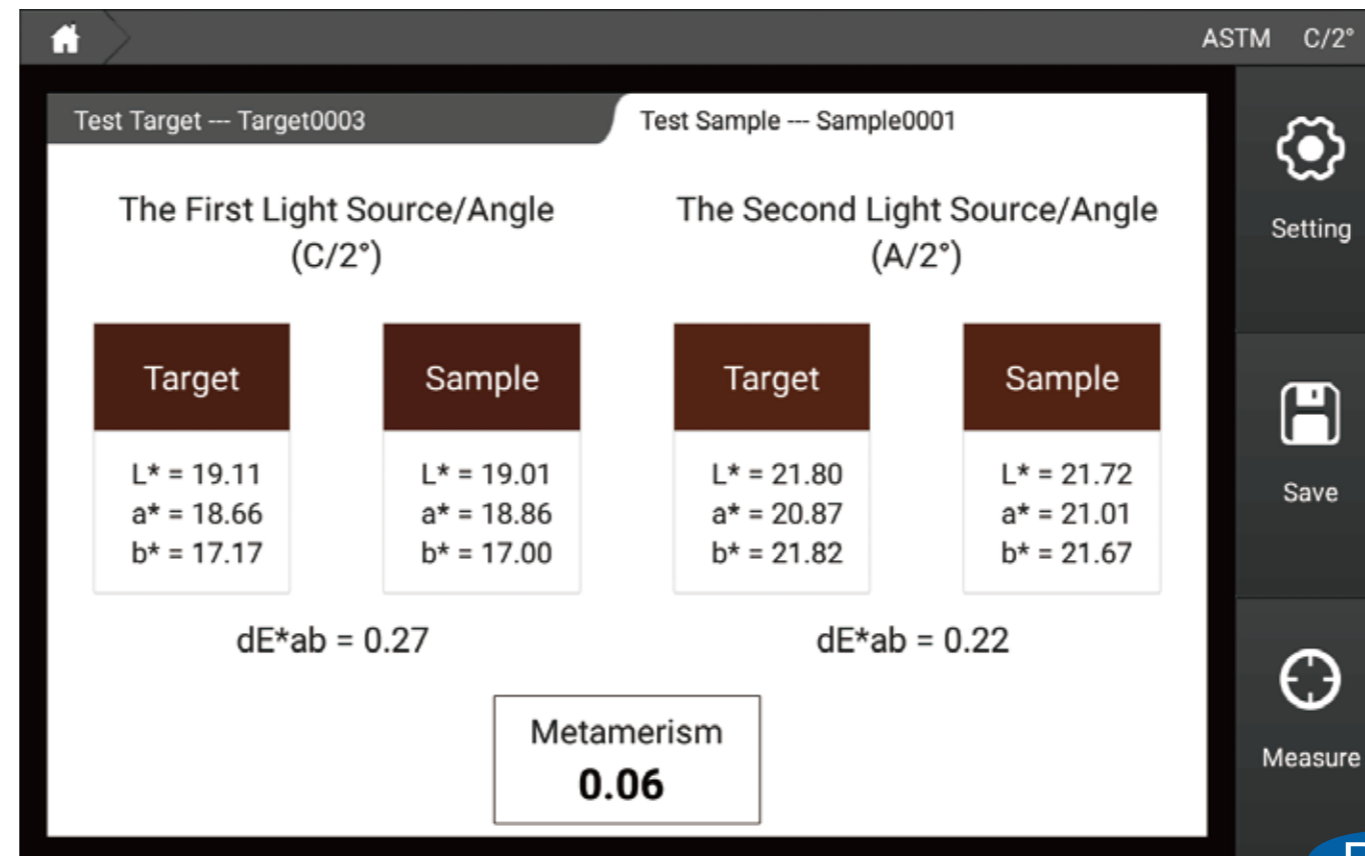

[Liquid color]

T-1

The cuvette optical path on the left of the interface is the recommended cuvette optical path size for measuring different parameters (for example, if you want to measure the saybolt parameter, the recommended cuvette optical path size at this time is 50mm), the right is the parameter value, and whether it is qualified Judgment.

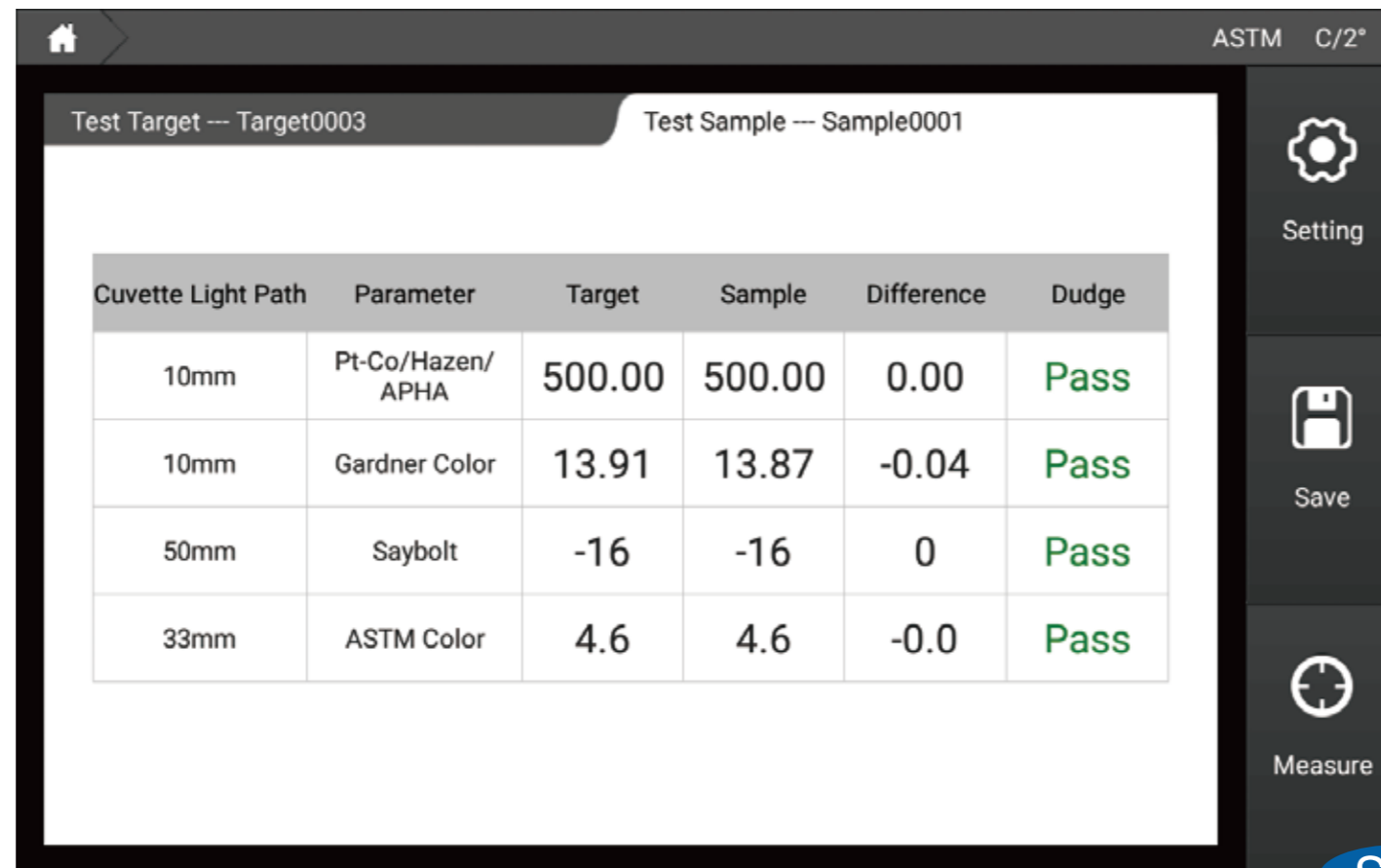

Cuvette Light Path	Parameter	Target	Sample	Difference	Dudge
10mm	Pt-Co/Hazen/ APHA	500.00	500.00	0.00	Pass
10mm	Gardner Color	13.91	13.87	-0.04	Pass
50mm	Saybolt	-16	-16	0	Pass
33mm	ASTM Color	4.6	4.6	-0.0	Pass

S-1

Parameter introduction

Haze

Diffuse scattering reduces the image quality of the object. Small particles inside the material or sample surfaces cause scattering, and scattered light is scattered to different angles and the optical density at each angle is small. It causes a decrease in contrast and the sample forms a milky or cloud-like appearance, this phenomenon is known as haze.

Conditions for the assessment of transparency

Transparent product appearance has the characteristics of gloss, color and transparency. Transparency is particularly important, and its evaluation conditions are: transmittance, haze and so on. The ratio of light to incident light when the transparency rate is all projected. It will decrease as the surface of the material reflects and absorbs light. According to the ASTM D1003 the percentage of light that when passing through that deviates from the incident beam by greater than 2.5 degrees on average is defined as haze.

Measuring principle

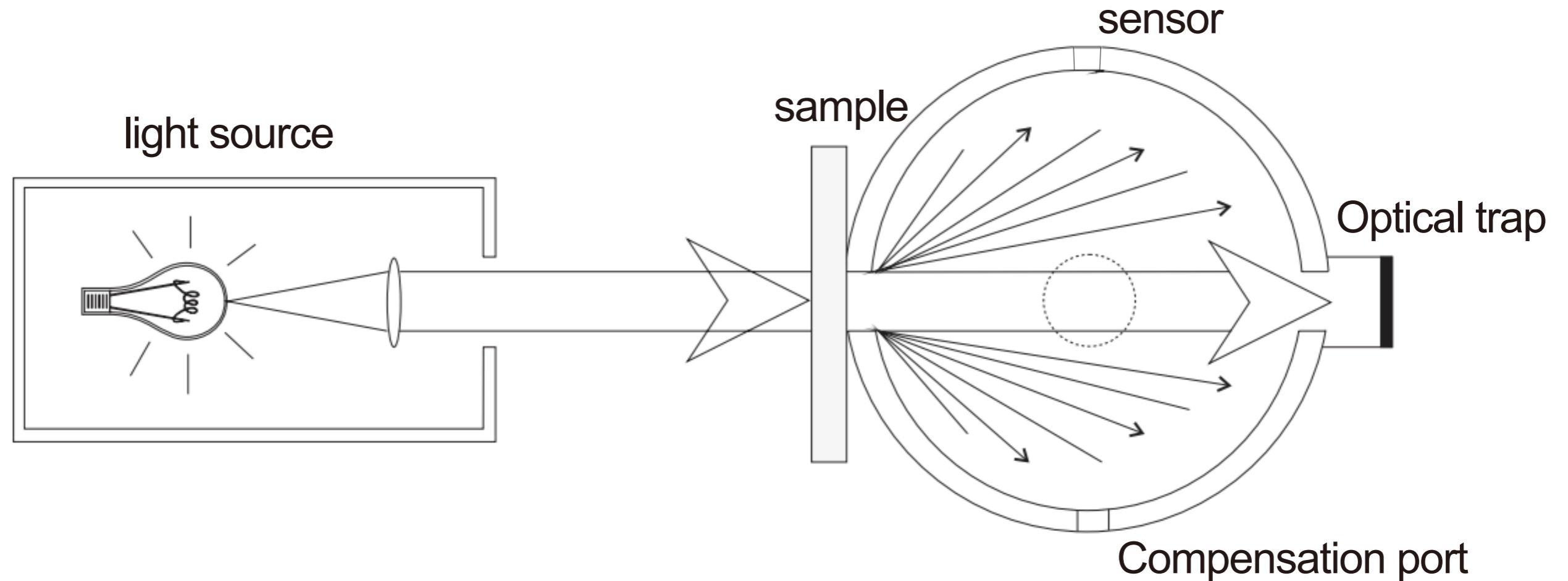

When a beam of parallel light hits the sample and enters the integrating sphere, it is scattered on the sphere inner white coating, the total transmittance is measured when the optical trap outlet on the sphere is closed. When the optical trap is opened, haze will be measured.

Compensation method

Incident light measurement

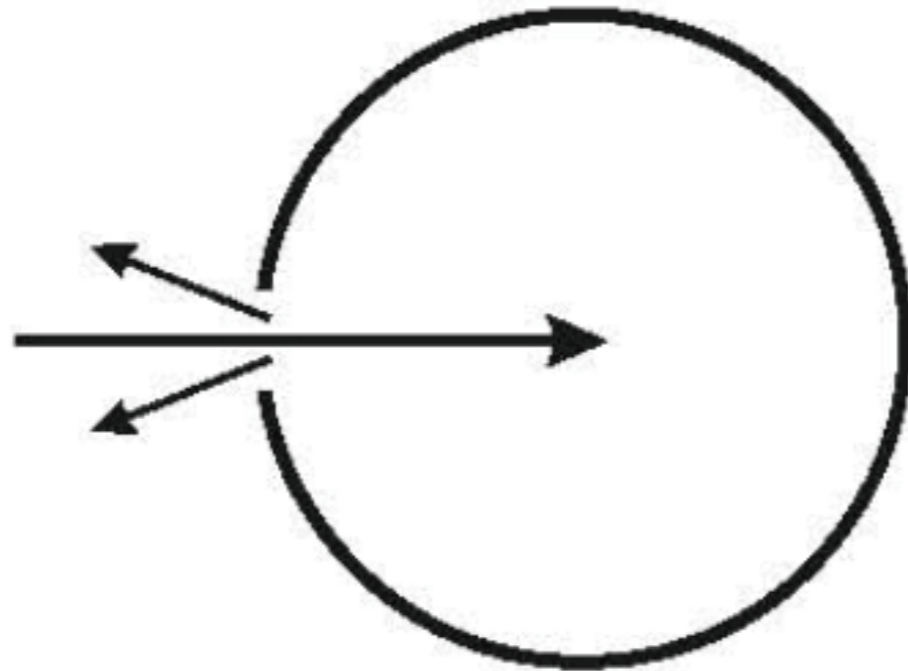

Transmission light measurement

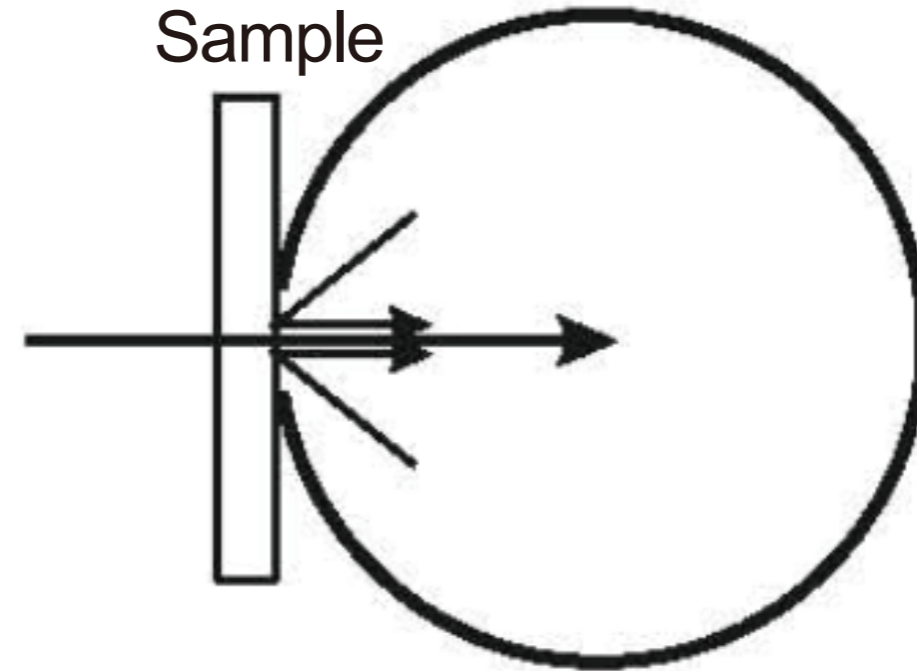

The above picture is not using the compensation method to measure the transmission rate, in two times measurement, because the integral sphere's area is different, causes the integral sphere efficiency are different, thus has the certain influence to the measurement result accuracy.

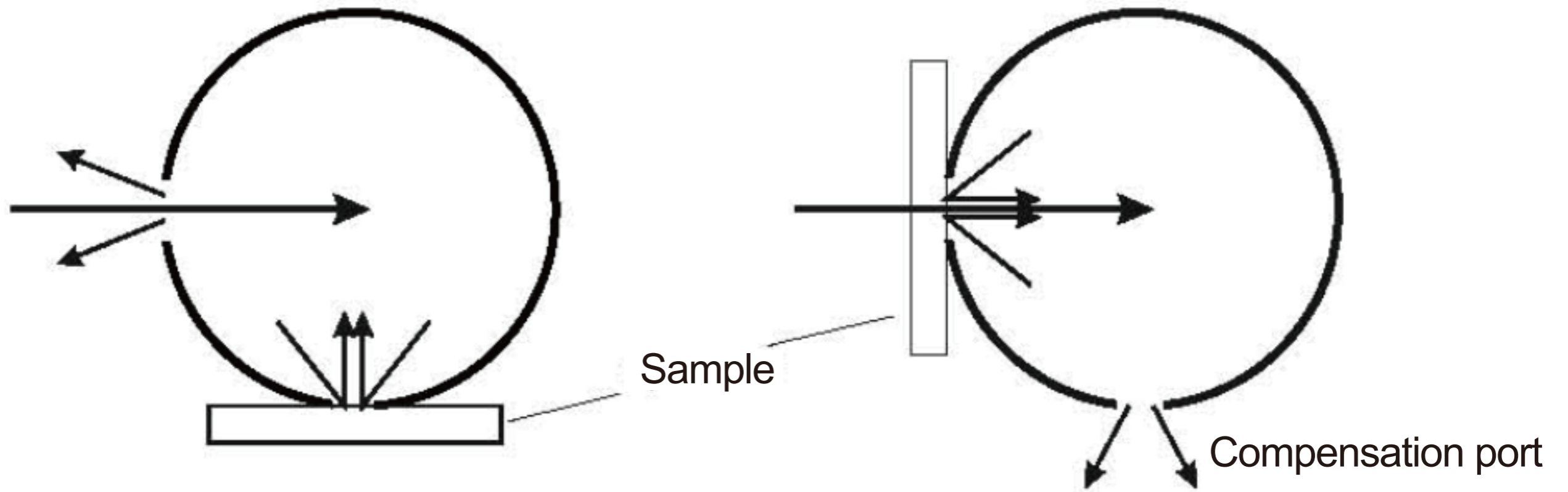

The above picture is used to measure the transmission rate by the compensation method, a compensating port is added to the integral sphere, the first measurement sample is placed at the compensation port, the second measurement sample is placed at the measuring port, while the compensation port is in the open state, the integral sphere area of the two measuring process is identical, the integral sphere is consistent, so that the measurement result is more accurate.

Exception handling analysis

Error	Analysis	How to solve?
1.The instrument does not start.	Power connection may be abnormal	Check the Power interface for good contact and plug in the power supply.
2.No access to main interface after start.	The power-on calibration process may be abnormal	Re-calibrate as required
3.Error in measurement results.	Tolerance settings may be abnormal	Check tolerance settings and adjust
4.Test result is not correct	<ol style="list-style-type: none"> 1.The sample is close to the test port or not 2.Whether the sample surface is with scratches 	<ol style="list-style-type: none"> 1.Check the sample and test port fit to ensure close fitting 2.Check the sample surface condition to ensure that the sample is at good condition and has no effect on the measurement.

Annex

Standard accessories

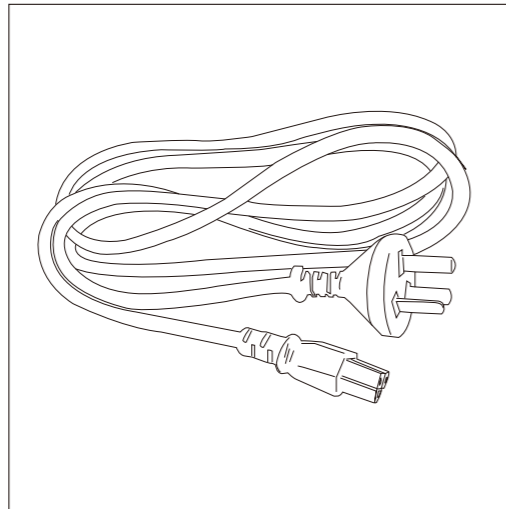

Power Adapter

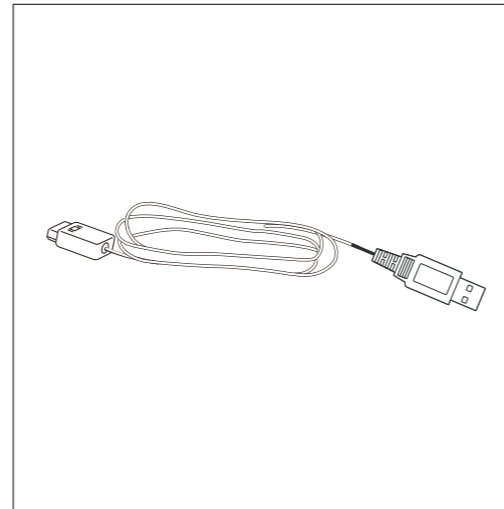

USB Cable

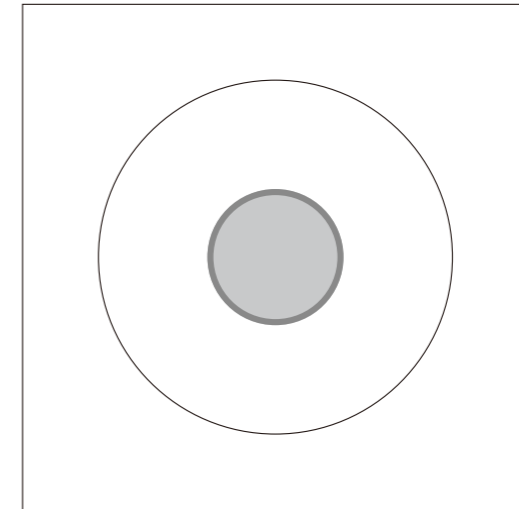

PC Software CD

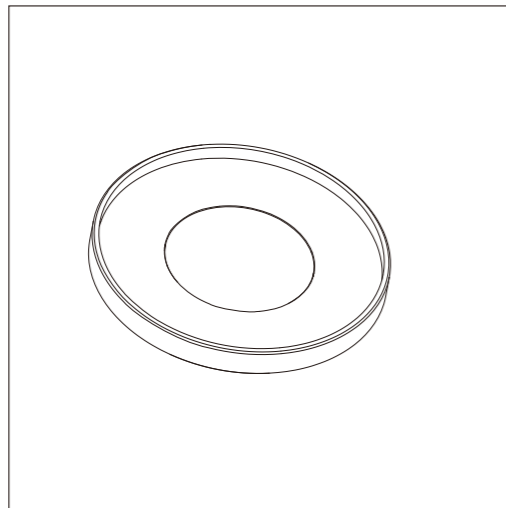

Compensation Port Cover

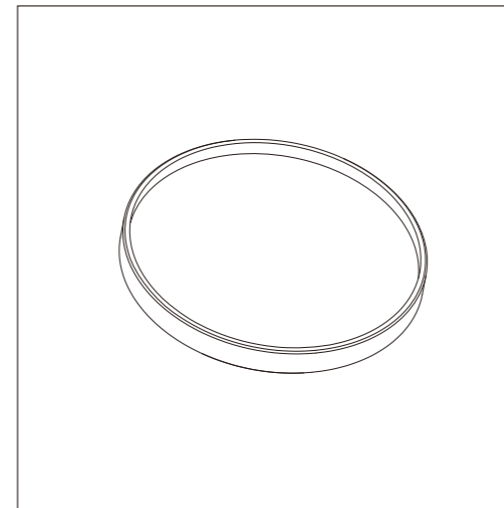

0% Calibration Cover

Select Accessories

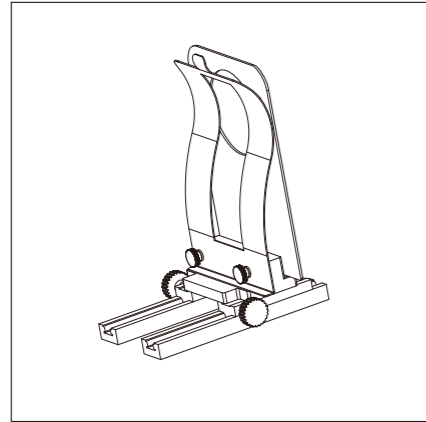

Film Sample Fixture

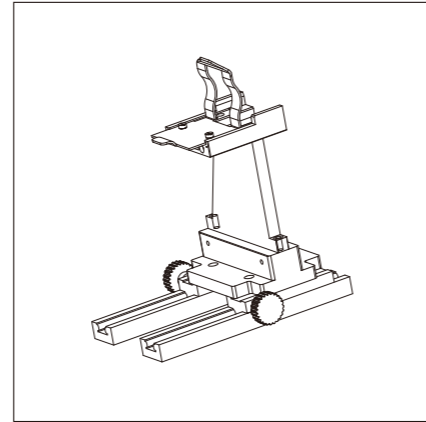

Liquid Sample Fixture

Company statement

- Our company commits to our customers 1 year warranty period for our Haze Meter series products from the date of the purchase, and our company shall be responsible to provide free maintenance for non-human caused malfunctions under normal usage. For malfunctions that are out of warranty period or caused by human factors, the company shall provide maintenance, and materials and repair shall be chargeable.
- The company is not liable for any loss or claim arising from the use of this product by the third party.
- The company is not liable for any damage caused by loss of data due to failure, maintenance or power off. To prevent the loss of critical data, be sure to back up all your data.
- The copyright of all products preset in this product belongs to the company and is protected by copyright law of the People's Republic of China.
- Our company's sale of this product does not represent the transfer or grant of any rights related to the copyright of the works, to the user.
- The product specifications and information mentioned in this specification are for reference only and will be updated at any time without prior notice.